

Constant Flow Valves

Constant Flow Rate Regardless of Pressure

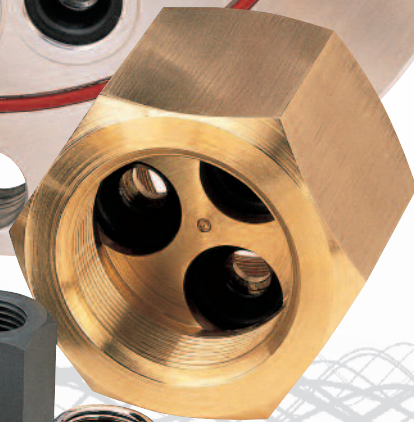

AUSTRALIA
Maric Constant
Flow Valves



Biggest Range of Flow Rates
Best Accuracy
20 Years Life Expectancy



Exported
Globally

www.maric.com

Maric Catalogue V1022



AUSTRALIA



Manufacturing plant in the outskirts of Adelaide, only 15 Minutes from Adelaide
CBD 15 Old Norton Summit Road, Teringie South Australia



Contents

Introduction		p 4
	• Assumptions	
	• What the Maric Valve DOES	
	• What the Maric Valve DOES NOT DO	
	• Benefits & Why Use a Maric Valve?	
	• Quality Assurance – The Company	
	• WaterMark Quality Certified – Quality Assurance – The Products	
	• How the Conventional Maric Flow Control Valve Works	
	• Understanding Headloss	p 5
Applications		
	• Summary	p 8
	• Mining	p 9
	• Water Authorities	p 10
	• Water Treatment	p 11
	• Industrial	p 12
	• Irrigation & Farming	p 13
	• Centrifugal Pump Protection	p 15
	• Domestic and Commercial	p 17
Valve Selection Guide		
	• Establishing Part Numbers	p 21
	• Valve Body Types	p 22
	• Control Rubber Types	p 23
Product Data		
Screwed	• Brass and Chrome	p 25
	• PVC	p 26
	• Stainless steel	p 27
	• Flow Control Check 15mm	p 28
	• Flow Control Check 25mm	p 29
Wafer Type	• Brass	p 31
	• Gunmetal	p 32
	• PVC	p 33
	• Stainless steel - Table D	p 34
	• Stainless steel ANSI/ASME	p 35
Insert Type	• Plain Inserts	p 37
	• Special & Water Meter Insert	p 38
General Information		
	• Installation Instructions	p 40
	• Operating Instructions	p 41
	• Maintenance	
	• Spare Parts	
	• Troubleshooting Guide	
	• Valve Identification	
	• Noise	
	• Life Expectancy	
	• After Sales Service	

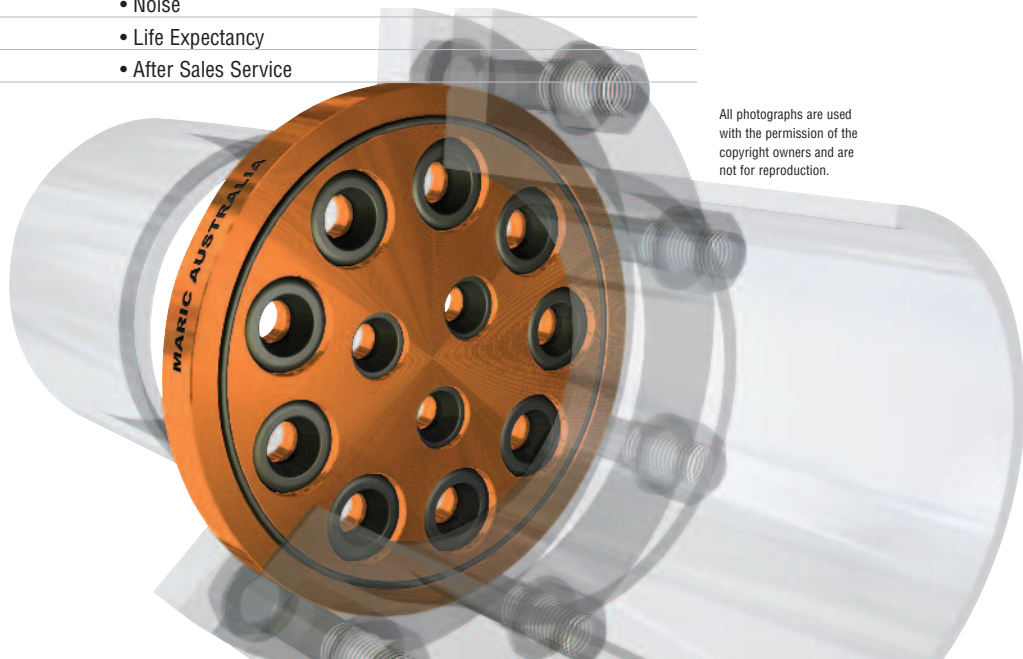

All photographs are used with the permission of the copyright owners and are not for reproduction.



Maric Constant Flow Valves

Constant Flow Rate
Regardless of Pressure



Est. 1963

This catalogue is designed to provide product and application data on Maric Flow Control valves. It also provides valve suppliers and engineers with the necessary information to establish full and precise Maric Flow Control valve specifications, and part numbers.

This document is also available for download on our website.

Assumptions

This document assumes that the user of the Maric flow control valves is aware of;

The desired pre-set flow rate for the valve.

What the Maric Valve DOES

The Maric flow control valve is designed to deliver a fixed, pre-set, constant (maximum) flow of water, irrespective of pressure differential across it, (within a given range).

This means constant flow rate, irrespective of fluctuating pressure upstream or downstream of the valve.

What the Maric Valve DOES NOT DO

The flow controller is not designed to control pressure.

The flow control valve has no external actuations and is not adjustable for flow rate.

Benefits & Why Use a Maric Valve?

For flow rate sensitive pumps, filters, pump glands, and water distribution systems, the installation of these valves can offer many benefits and valuable protection.

The valves boast automatic, maintenance free, and self cleaning operation.

The valves useful life can be up to 20 years.

They are compact and are available in the broadest range of connection types, sizes and material types in the world.

Quality Assurance – The Company

The Company has a recognized and regularly externally audited Quality Assurance System which ensures a consistent and high level of quality. Our quality assurance system is SAI Globals "Product Compliance Program", PCP14.02 WaterMark level 1. This system is based on ISO9001.

WaterMark Quality Certified Quality Assurance – The Products

The Products must also comply with the specifications of the appropriate Australian Standard. The standard for Maric's Flow Control valves is; Australian Technical Standard; ATS5200.037.1 – 2006-FLOW CONTROLLERS. This specification includes, but are not limited to; Design; AS3688, Materials; AS1567, AS2345, Potable water suitability AS4020, End connections; AS ISO 7.1, AS1722.2, AS4087 & AS2129, Hydrostatic pressure test & water-tightness; AS3718, Flow rate; AS1357.2, Marking & Product documentation.

How the Conventional Maric Flow Control Valve Works

The flow control valves utilise a flexible rubber control ring, with an orifice diameter that responds instantly to fluctuations in water pressure.

As pressure differential increases, the orifice diameter reduces to maintain the pre-set flow rate.

Likewise, as pressure reduces, the orifice opens up to maintain the pre-set flow rate.

These valves are particularly suitable for use on poor water quality, because the flow controlling element is a rubber material, and flexes under normal operation. This minimises the risk of blockage, and eliminates the build-up of scale.

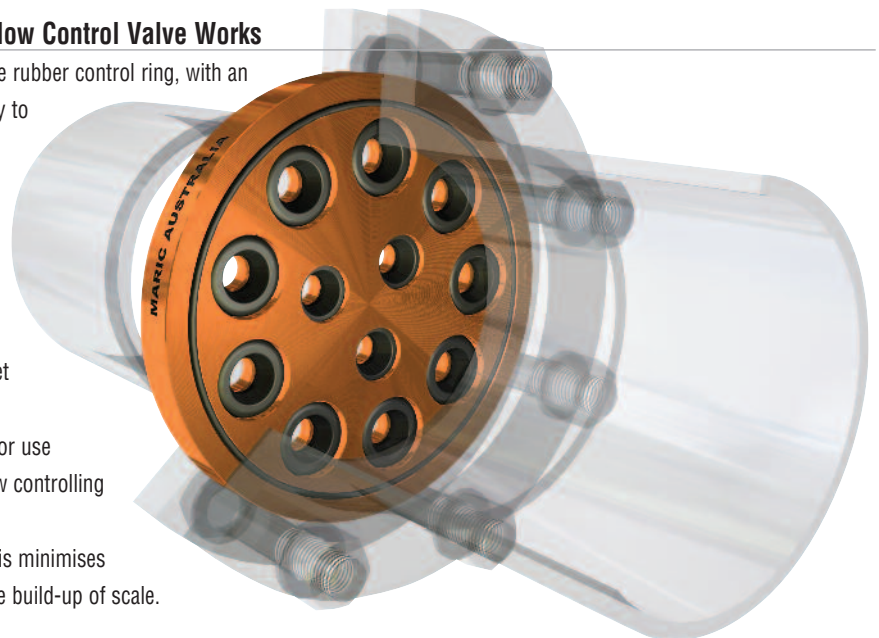

www.maric.com

Ph: +61 8 8431 2281



Maric Constant Flow Valves

Constant Flow Rate Regardless of Pressure



Est. 1963

Pressure Differential Characteristics of Maric Constant Flow Valves

The “Headloss” of Maric valves is commonly misunderstood. For determining what the headloss or pressure differential will be **prior** to installing a Maric valve, please refer to instructions over the page.

VALVE FUNCTION Maric valves maintain a constant, pre-set, flow rate, irrespective of pressure (within a range), by means of a precision moulded rubber control ring, whose orifice diameter varies, as the pressure differential across it varies. The greater the pressure, the smaller the orifice, and vice versa. Therefore constant flow rate.

HEADLOSS - DEFINITION Headloss, or "Pressure Drop" across the valve, is simply the difference between inlet and outlet pressure, and is determined by the installation, not necessarily the flow controller. The "PRECISION" range of valves is designed to provide constant flow, when pressure drop across them, is anywhere within the range of 140 to 1000 kPa. (14-100 metres, 20-150 psi, or 1.4-10 Bar).

HEADLOSS - PRECISION MARIC VALVES

Headloss at rated flow is 140 kPa At lower than rated flows headloss reduces significantly. ie; To obtain full rated flow (accurate to within +/- 10%), the system must provide for inlet pressure to be at least 140 kPa greater than outlet pressure.

Performance Curve for “Precision” Valves, 140 – 1000 kPa

The performance curve below, shows typical performance of all Precision valves, irrespective of body size or flow rate. As can be seen from the graph, peak flow rate is obtained when differential is around 400 kPa.

Extreme ends of the pressure range result in flows usually around 5 to 8% below rated.

Performance graph for standard valves with control rubber type, Precision

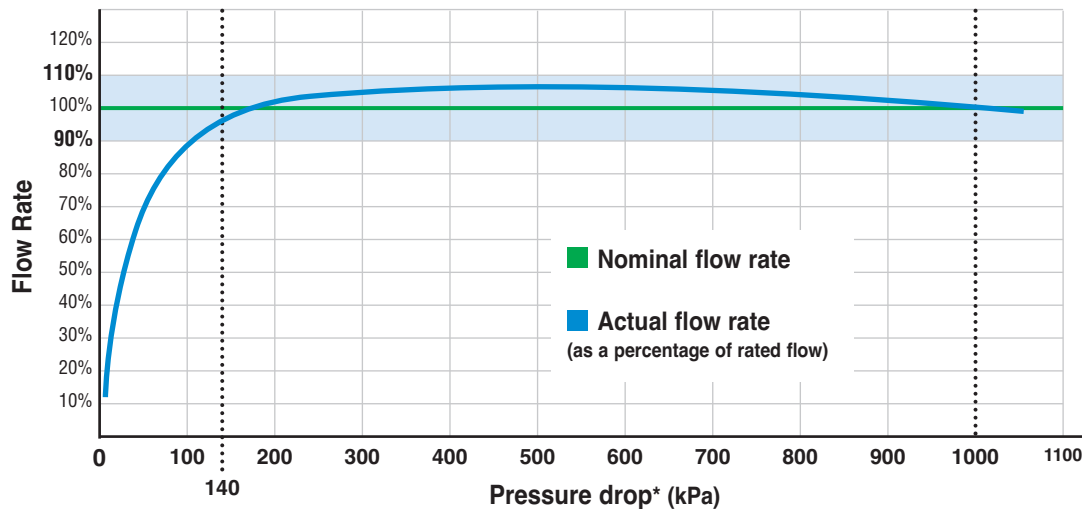

* Pressure drop is the difference between inlet and outlet pressure across the valve.

EXPLANATION The "Precision" range of valves is designed to handle most “mains” or similar pressure applications. It is often misunderstood when it is said that the headloss across the Maric valve is 140 kPa. This would be true if supply pressure was only 140 kPa, and outlet pressure was zero (atmospheric). If however supply pressure increases to 1000 kPa, and outlet pressure remains at zero, then headloss becomes 1000 kPa. In either case the valve will be operating within design parameters, and controlling flow. Therefore, the pressure drop “range”, of 140-1000 kPa, must always be considered. Not just the 140 kPa.

If 140 kPa headloss is too high for your application, or if 1000 kPa is not high enough, then the “low pressure” or “high pressure” type Maric valves should be used. See below for more information on these. If the demand for water is less than the valves nominal rated flow, i.e. less actual flow, then pressure drop across the valve will drop to much less than 140 kPa. For example, from the performance curve above, at 50% of rated flow, pressure drop across Maric valve is only around 30 kPa and at 30% of flow, only 12kPa.

Most Maric valves will handle a hydrostatic pressure of well in excess of 4000 kPa. Precision valves will function satisfactorily with inlet pressures above 1000 kPa, provided that outlet pressure is never more than 1000 kPa less than inlet pressure. This practice is not recommended however, because if the outlet pressure does ever drop to zero, then valve failure may result as below. If differential across valve is sufficiently high enough above specification, it may cause the rubber control ring to blow right through the orifice, and be lost downstream, resulting in either, the valve body having a relatively large diameter fixed orifice, and allowing a potentially very high and uncontrolled flow rate, or, the control rubber becoming lodged in a fitting downstream and blocking flow rate partially or completely.

www.maric.com

Ph: +61 8 8431 2281





Est. 1963

Where pressure differentials must exceed 1000 or 1500 kPa, the use of high pressure valves is strongly recommended.

Low Pressure Valves. Have a pressure differential operating range of approximately 40-400 kPa. Flow rate accuracy is +/- 20%
High Pressure Valves. There are two models available, 140-1500 kPa, and 170-2000 kPa. Flow rate accuracy is +/- 20%

The flow rate accuracy of the Maric valves (any valves for that matter) is not exact. All "Precision" control Rubbers are performance tested immediately prior to dispatch from the factory, and must not deviate above or below nominal flow by more than 10% throughout their entire pressure differential range. In most cases accuracy is better than +/-8%.

Calculating Headloss Prior to installation.

The following explanation is provided to assist in determining what the Headloss (pressure differential) will be across the Maric valve, before the valve is installed, for the purpose of determining the valves suitability for the application.

Firstly understand that the whole purpose, of installing a Maric valve, is to maintain constant flow rate, **irrespective**, of the pressure drop across it, (provided that it is within the valves designed pressure drop range). However, Maric are still often asked; "What will the headloss be across the valve?".

We can not advise what the pressure differential will be. But it should be possible to calculate it if you have sufficient installation data available. It will then be possible to select a valve of the appropriate pressure differential range for the application.

The pressure drop across the valve will in fact be determined by the parameters of each individual installation.

If you are unsure if a Maric valve will be suitable for a particular application, it will be necessary to predict what the pressure differential will be across the valve by calculating as described below.

CALCULATING PRESSURE DROP

The differential across our valve, as explained earlier, will simply be the difference in pressure between the inlet and outlet. It sounds too simple to be worth stating, however, with potentially fluctuating inlet and outlet pressures, it is worthy of a brief explanation.

Firstly, let us assume the valve is limiting flow to the desired rate. Then determine, (at that flow rate) what will be the maximum and minimum possible *inlet* pressures. Then determine the maximum and minimum *outlet* pressures likely to be encountered.

The maximum pressure differential will be the maximum inlet, less the minimum outlet pressure.

The minimum pressure differential will be the minimum inlet pressure, less the maximum outlet pressure.

When performing these calculations, it is vital that they are done **at the desired flow rate**.

This calculated minimum and maximum pressure differential, should fall within the range of one of the Maric valves types available. If not, then installation design changes will be required.

Inlet Pressure calculations, - consider the following;

- A Supply pressure fluctuations.
- B The pumps performance curve. i.e., pressure produced at the required flow rate.
- C Associated line frictional losses between the pump and the valve.
- D Any vertical lift component which will reduce pressure to the valve.

Outlet Pressure calculations, - consider the following;

- A Demand fluctuations.
- B Any vertical lift required after the valve.
- C Associated frictional line losses to the ultimate destination.
- D Pressure losses or requirements associated with downstream valves, filters, nozzles, other pumps, sprinklers, or stuffing box resistance etc.

www.maric.com

Ph: +61 8 8431 2281





AUSTRALIA
Maric Constant
Flow Valves



Valve Applications

Summary

Mining

Water Authorities

Water Treatment

Industrial

Irrigation and Farming

Centrifugal Pump Protection

Domestic and Commercial



Exported
Globally

www.maric.com

V1022

Maric Constant
Flow Valves

Constant
Flow Rate
Regardless
of Pressure



Est. 1963

MINING;

Gland water flow control to gland-packing/stuffing box and mechanical seals of centrifugal and slurry pumps.
For **water treatment, process water control, fire fighting, safety showers, centrifugal pump protection & dust suppression.**

WATER AUTHORITIES;

Flow limiting, for non-payment of water bills - **Boosting mains pressure - Extending water meter life - Enabling economical distribution to rural, semi-rural connections - Flow control instead of water meters** and to **Force water restrictions.**

WATER TREATMENT;

Back-wash flow rate control for preventing media loss - Service water flow rate control through delicate filters - Control trickle flow to water quality analysing equipment - Ultraviolet water sterilisation, controlled speed = controlled bacteria kill. Water Softeners, for preventing loss of crystals during back-washing.

CENTRIFUGAL PUMP PROTECTION;

For **keeping a pump on its curve and preventing cavitation damage** - For **use on high draw-down bores** for preventing up-thrust damage - For **preventing over-pumping beyond bores capacity** & drawing in of air or sand, leading to unstable conditions - **Protection from overloading of electric motors** - **Control of cooling water to liquid ring vacuum pumps.** Gland-water & mechanical seal - **Seal water flow control.**

INDUSTRIAL;

Vacuum Pumps, for controlling flow of crucial sealing/service liquid to liquid ring vacuum pumps.
Fire Fighting, pump protection - Controlled maximum flow ensures correct operation for type of nozzle used, also for use in conjunction with smaller flow valve for correct ratio dosing of foaming agent.
Dust Suppression, sprinkler control on mobile water tankers - Dust & erosion control of crusher output and tailings mounds via sprinklers.
Distilleries and Cooling Equipment - provides correct flow of cooling water to still condensers.
Industrial Linen and Dishwashing Machines - prevents a large drop in mains pressure whilst filling.
Safety Showers & Eyewash Equipment - controlled flow ensures consistent and safe operation.

DOMESTIC SHOWERS BASINS;

Water conservation - Kwyflo valves are recommended for quiet operation.
Drinking Fountains - Controlled stream prevents frustration at the drinking fountain.
Toilet Cisterns - Prevents the potential "continuous flush" operation if fill rate is too fast.
Water Heaters - Keeping flow below a pre set maximum ensures gas & electric instantaneous heaters can heat to a sufficiently hot & advertised temperature.

IRRIGATION;

Sprinkler flow control, over-spraying mists and/or wastes water and under-irrigating wastes time - Fitted to each outlet ensures uniform output at different elevations.



www.maric.com

Ph: +61 8 8431 2281



Constant Flow Rate Regardless of Pressure



Est. 1963

Valve Applications Mining Applications

Various processes within the mining industry require water flow to be maintained at a constant rate.

Applications include;

- Glandwater flow control
- Mechanical seal flow control
- Water treatment
- Process water control
- Safety showers & Eye Washing equipment
- Pump protection
- Dust suppression
- Fire Fighting
- Liquid ring vacuum pump seal / cooling water
- Plant washdown hoses
- Other industrial applications

Please refer to our website for comprehensive information regarding Maric Flow Control valves for mining applications and glandwater flow control. This is in pdf (downloadable) format .

Gland-Water Flow Control

The Maric flow control valve is designed to deliver a fixed constant (maximum) flow of water, irrespective of pressure differential across it, (within a given pressure differential range).

In the case of slurry pumps, this means, the Maric flow control valve will maintain a constant flow of glandwater ;

Regardless of :

1. fluctuating gland-water supply pressure,
2. gland condition, or
3. slurry pump discharge pressure.

Benefits, & Why Use a Maric Valve?

Maric Flow Control valves are used to;

- **Protect centrifugal pump glands**, through;
 - Ensuring adequate constant flow rate,
 - Ensuring glandwater availability in the event of failure of any one or more centrifugal pump glands on a common glandwater supply. Relatively high flows through glands are not of particular concern here, as long as the glandwater pump can maintain the supply.
- **Prevent unnecessary dilution of slurry**, (or liquor in the alumina refining industry) by ensuring that glands cannot receive more than a pre-determined flow rate. A lower than set rated flow is not a particular concern here, as the condition of the gland will ultimately determine flow rate, up to the pre-set maximum permitted by the flow controller. Full rated flow of the flow controller will only result when gland is sufficiently loose enough or worn to enable it.
- **Minimise wastage of available packing water supplies.**

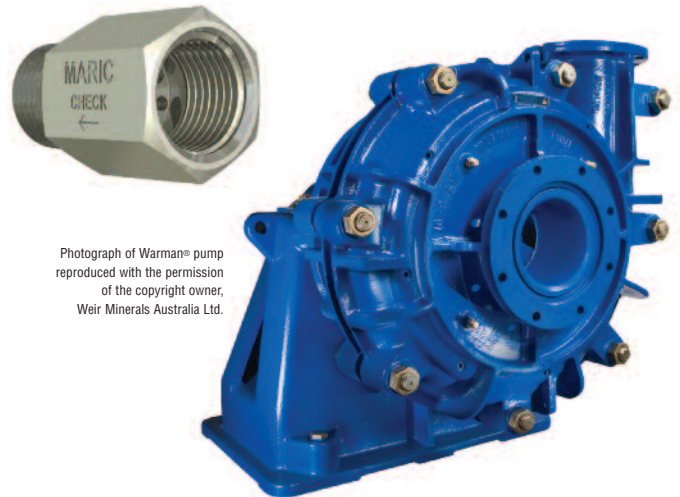

Photograph of Warman® pump reproduced with the permission of the copyright owner, Weir Minerals Australia Ltd.

www.maric.com

Ph: +61 8 8431 2281



Maric valves control gland-water flow rate to three stage slurry pumping facility at Roxby Downs uranium mine South Australia"

Controlling flow rate of high octane fuel at BP Refinery

Dust suppression and slurry pumping facilitated by water flow controlled with Maric Valves

Maric Constant Flow Valves

Constant Flow Rate Regardless of Pressure



Est. 1963

This list shows how the use of Maric flow control valves, at water meters, has benefited Water Authorities.

- A. The use of 2.0 litre per minute tail inserts are an invisible and tamper resistant means of accurately restricting flow for non-payment of water bills.
- B. Limiting maximum flow, helps ensure minimum mains pressure is maintained during peak demand. This can help ensure the last property on the line gets its fair share, and may also prevent the costly exercise of needing to increase the mains pipe size to cope with an increased population.
- C. Significantly extended water meter life is obtained when maximum flow is kept within meters design parameters.
- D. May facilitate an economical means of distributing water to vast areas of semi-rural, sparsely populated country. A very small and inexpensive water main, perhaps as small as 50mm, and hundreds of kilometers long may be used if flow is limited to a minimum continuous supply. Consumers fill their own tanks for a practical supply.
- E. In Queensland some authorities provide valves at a low flow rate, instead of water meters. This is a significant cost reduction to authorities, and consumers pay according to flow rate requested or offered. As above, consumers fill tanks for a practical supply.
- F. Perhaps they could be used also in times of water shortage? Could they offer an alternative to "water restrictions"?
- G. Reduced pumping costs - lower peakflow = smaller pumps.

Valves are available to suit meter sizes from 15mm up to 150mm.

They are WaterMark certified (based on ISO9001) and approved for use in contact with drinking water.

See below; Water Authorities using Maric Flow Control Valves.

Riverina Water;	Jason Ip, Operations Manager, 02 6922 0658
Water Corporation of WA;	Tony Borromei, Meter Co-ordinator, Mob: 0419 190 891
SA Water;	Tom Plant, Mob: 0428 282 206
Scenic Rim Regional Council;	Joe McPhail, Foreman, Water & Wastewater, Mob: 0407 657 143
Busselton Water Board;	Jason Rice, Water Tariff Officer, 08 9781 0500
Calliope Shire Council;	Craig Murrell, Manager, Infrastructure Planning, 07 4975 8100
GWM;	Phil Childs, Resources Manager, 1300 659961
Barwon Water;	Henry Freise, Meter Management Leader, 03 5226 9259
Bega Valley;	Darryl Parker, Purchasing Office, 02 6499 2222
Central Highlands;	Ian Oldham, Metering Manager, 03 5320 3100
Coliban Water;	Darryl Sligar, Operations Manager, 02 6368 2208
District of Yorke Peninsula;	Kerri Carr, General Manager Customer Service, 1300 363 200
Emerald Shire Council;	Grant Smith, 08 8832 0000 Mob: 0427 848 830
Gippsland Water;	Dan Pymble, Manager, Water Utilities, 07 4982 8367
Wannon Water;	Dennis Tomich, Property Services Manager, Schultz Plumbing, Mob: 0404 047 155
Goulburn Murray Water;	Denis Holmes, Supervisor, 03 5551 0400 Mob: 0407 052 187
Goulburn Valley Water;	Trevor Kolpin, Salinity Officer, Mob: 0417 394 931
Narrabrai Shire Council; North	Steven Nash, 03 5832 0452
East Water;	Rod Liversidge, Water Manager, 02 6799 6877
Wyong Shire Council;	John McDiarmid, Metering Coordinator, 02 6022 0555
	Phil Lerway, Water Services Administrator, 02 4350 5555

Selection of flow controllers for smaller water meter and tail applications

Typical installation of inserts in 20 & 25mm meter & tail assembly

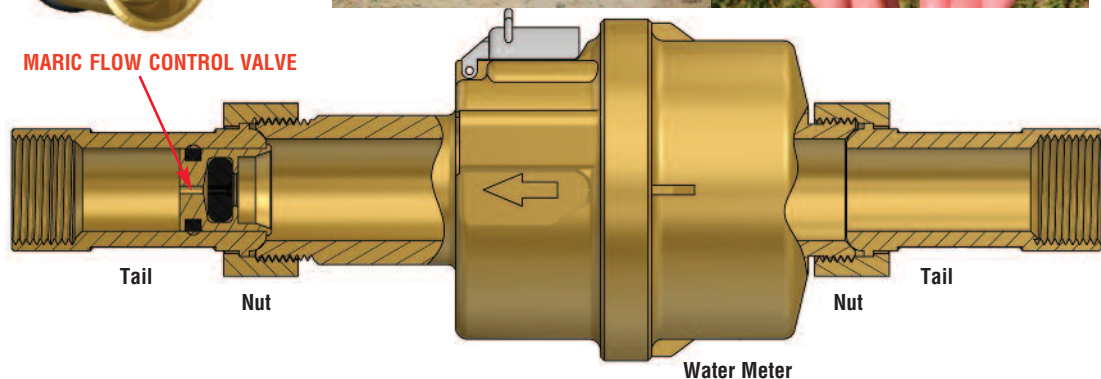

www.maric.com

Ph: +61 8 8431 2281



Maric Constant Flow Valves

Constant Flow Rate
Regardless of Pressure



Est. 1963

Various processes within water and wastewater treatment require water flow to be maintained at a constant rate.

A variety of technologies are utilised to achieve this constant flow rate, and one reliable and maintenance free method is to use Maric flow control valves.

Maric flow controllers can be used to;

- Control backwash flow rate to prevent loss of media in media filters.
- Control of service water flow through delicate filters.
- Preventing “coning” of membranes
- Control trickle flow of sampling water to analysing instrumentation.
- Control maximum flow of treated waste into the municipal sewer system.
- Limit peak flow rate through ultraviolet sterilisers to ensure 100% bacteria kill.



Osmofo Australia use Maric valves to control flow in a reverse osmosis water treatment plant

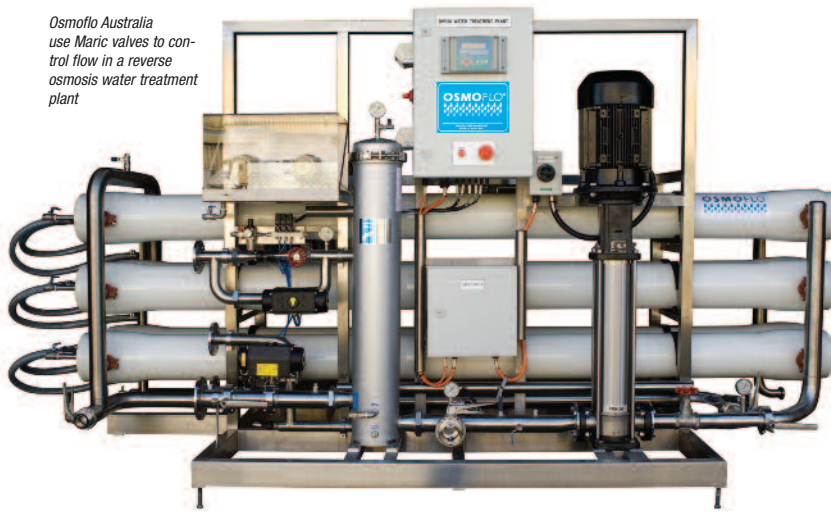

- Control flow of carrier water to coupon rack in cooling tower, water treatment installations.
- Chemical dosing flow rate control.

Maric flow controllers are:

- Tamperproof: Maric valves are non-adjustable, which prevents unwanted system changes.
- Maintenance free, reliable and self cleaning. As there are no wearing parts, the valves require no maintenance, adjustment or cleaning for their 20+ year life.

Maric valves control backwash flow rate in a media filter

Control flow through Reverse Osmosis membranes and Brine Discharge Flow Rate

Municipal water treatment has many applications for Maric flow controllers



www.maric.com

Ph: +61 8 8431 2281



Constant
Flow Rate
Regardless
of Pressure



Est. 1963

Valve Applications

Industrial Applications

Industry requires controlled water flow in numerous applications. Maric Flow Control Valves are often used in the following applications;

- **Safety showers & eye washing equipment** – ensures adequate flow to all shower stations, controlled flow = safe flow to eyes.
- **Fire fighting**
 - guarantees availability of adequate flow to all hydrants in the event that they all require water at the same time
 - controlled max flow ensures safe and correct flow from each nozzle - for use in conjunction with smaller nozzle for correct dosing of foaming agent. See also pump protection section.
- **Liquid ring vacuum pump seal/service liquid**
- **Industrial linen washing machines** – controlled flow maintains mains pressure.
- **Distilleries and cooling equipment** – minimises waste, by controlling condenser cooling water flow.
- **Power station** – demineralization water treatment equipment.
- **Plant washdown hoses**
- **Dust suppression** – ensures consistent flow from all spray nozzles.
- **Chemical Dosing Flow Control**

See also:

- **Glandwater and mechanical seal flow control** – refer *Mining* page 9 for more information
- **Industrial water and wastewater treatment** – refer *Water Treatment & Filtration Equipment* page 11 for more information
- **Centrifugal pump protection** – refer *Pump Protection (Centrifugal)* pages 15 & 16 for more information

Maric valves control gland-water flow rate to three stage slurry pumping facility at Roxby Downs uranium mine South Australia

Valves for North Sea oil Rig and tanker fire fighting

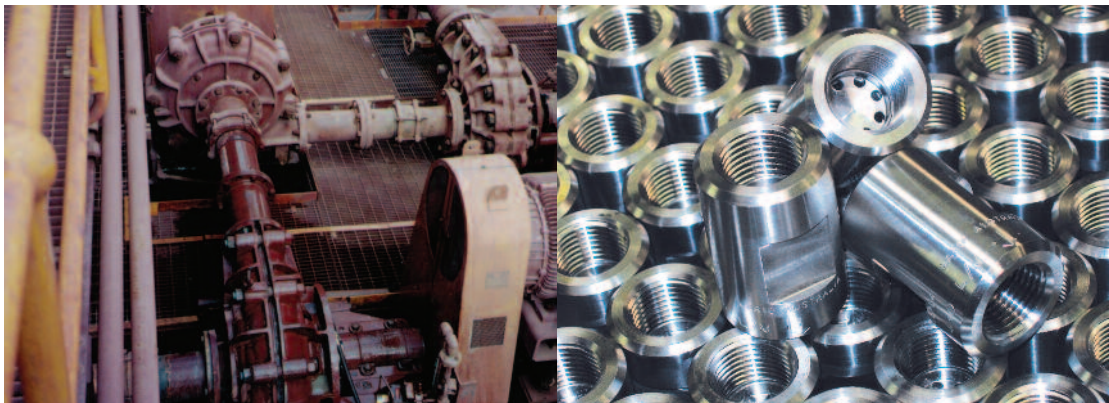

www.maric.com

Ph: +61 8 8431 2281





Irrigation & Farming requires controlled water flow in numerous applications. Maric Flow Control Valves are often used in the following applications;

- **Centrifugal pump protection** – Maric flow controllers can prevent cavitation or thrust bearing damage caused from excessive flow rate. *(refer Pump Protection (Centrifugal) pages 15 & 16 for more information.)*
Too high a flow rate can damage pumps when;
 - Gate valve is unwittingly opened
 - High standing water table exists at start-up
 - Pipework is empty at start-up
 - Capacity of bore deteriorates below current pumping rate
 - Pipework bursts
 - Pump is required for two different flow rate duties

- **When an authority enforces limits to, (or reduced) pumping rates, with a non-adjustable valve.**

- **Preventing electric motor overload** – limiting pump output also limits power draw and potential overload tripping.

- **Fertiliser dosing for irrigation** – *refer Irrigation & Farming page 14 for more information*

- **Vitamin dosing for stock** – dosing equipment.

- **Equitable distribution over vast distances** (cap and pipe the bore schemes) – provides an economical means of distributing water to numerous properties over vast distances. Limiting flow to a known maximum flow rate will ensure mains pressure is maintained and the last property will receive their allocation.

- **Irrigation Water Treatment** – Backwash flow rate control

- **Sprinkler control** – over-spraying wastes water and under-spraying wastes time (ensures consistent output irrespective of sprinkler elevation or available pressure.)

- **Tank/water trough fill rate control** – Limiting flow to known maximum flow rate, will ensure adequate line pressure to the end of the water main.

- **Prevent collapse of bore**

Controlled flow protects submersible centrifugal pump

Gunmetal wafer type valve mounted between flanges





Est. 1963

Fertigation Using Maric Flow Controllers

In spite of available pressure, or distance from supply, or elevation
flow control valves ensure uniform fertilizer delivery.

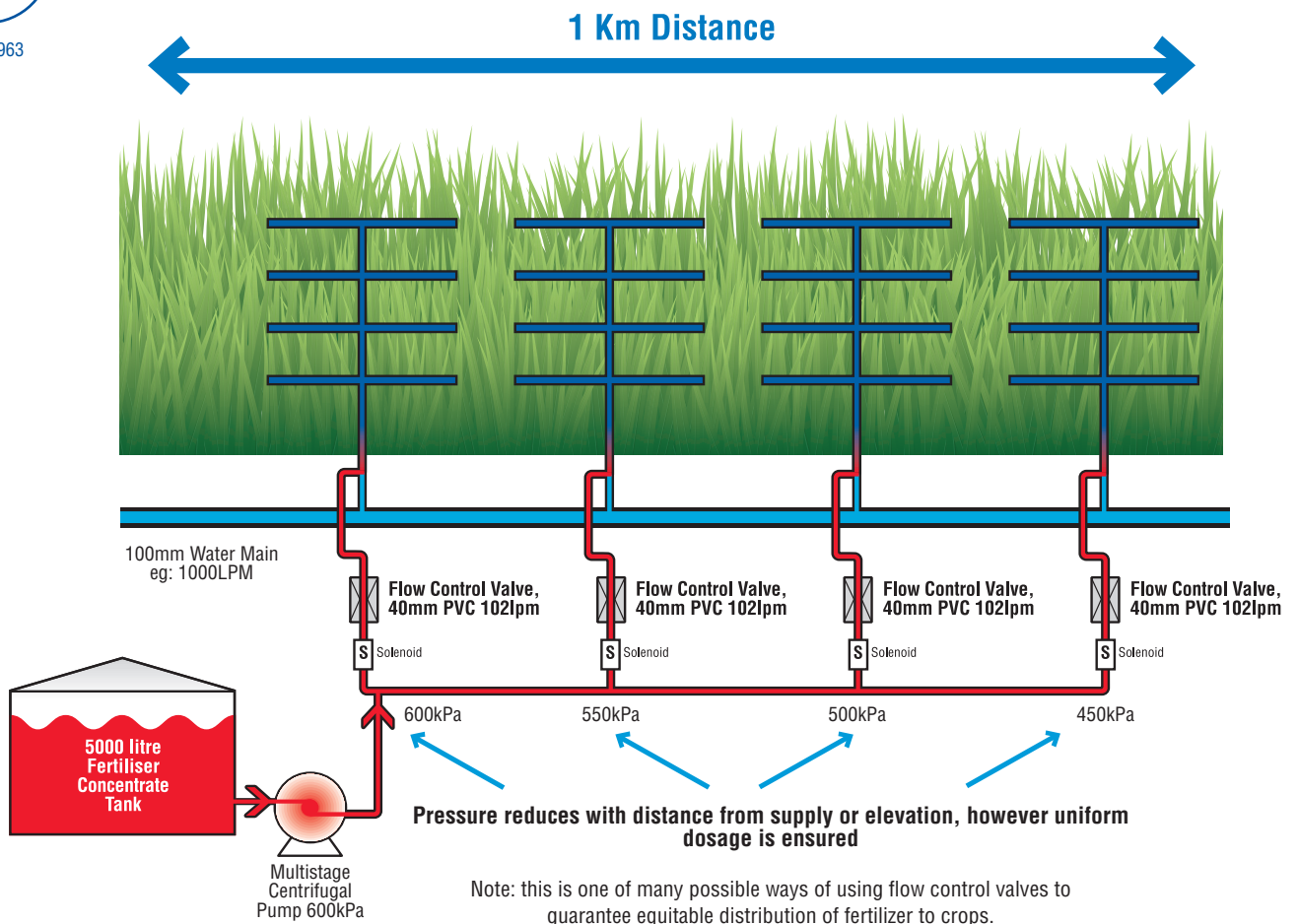

www.maric.com
Ph: +61 8 8431 2281

Typical Maric flow control valve,
40mm F&F PVC Precision,
102 litres per minute



Maric Constant Flow Valves

Constant Flow Rate Regardless of Pressure



Est. 1963

A tamper-resistant method, of protecting centrifugal pumps from running off their curve, is to place a correctly sized Maric flow controller, close to the pump discharge.

Introduction:

A common cause of centrifugal pump failure, is from cavitation or up-thrusting, through having been allowed to "run off their curve". For long, trouble-free life, flow rate and head should be maintained within manufacturers specifications.

Why use a Maric Flow Controller?:

For centrifugal pumps, limiting maximum flow rate, ensures a particular head is achieved.

Therefore, because Maric valves limit maximum flow rate, they are useful for keeping pumps on their curve.

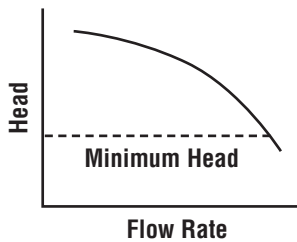

An added bonus is, they are tamperproof, preventing unauthorised adjustment, and they require no maintenance.

A typical pump performance curve is shown to the left

Alternatives:

Gate valves and pressure sustaining valves are often used to apply head, however, their disadvantages include:

- reduced pump output, (efficiency), at the duty point through unnecessarily high headloss
- adjustment by the untrained
- failure due to wear
- they require maintenance

Maric constant flow valves offer protection without these disadvantages.

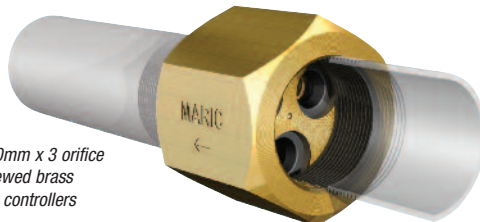

Maric 50mm x 3 orifice screwed brass flow controllers

Headloss:

Maric flow controllers are particularly ideal for submersible installations with a high standing water table.

The Maric valves are designed to control, (or limit) flow rate, regardless of pressure changes.

I.e., its orifice diameter varies automatically. Its orifice opens as the pressure differential across it reduces, and vice-versa.

Therefore, headloss will be what ever it needs to be, in order to maintain the set flow rate.

For pump protection purposes, the flow rate selected for the Maric valve, is usually close to the right hand side of the pump curve.

But quite often, the duty point of a pump is well in from the right hand side of the curve.

In the case of a high standing water table, where the duty point flow rate, is less than the rated flow of the Maric valve fitted, then the headloss across it is **significantly** less than 140 kPa.

For example, when flow through a Maric valve is 70% of its rated flow, its headloss is 40 kPa only. (See Maric curve over the page)

This is a significant benefit over "fixed orifice" gate valves, whose orifice remains relatively restrictive at the duty point, reducing pump output and efficiency.

So, Maric valves ideally suited to High Standing Water Table installations, where the Maric valve is only operating within

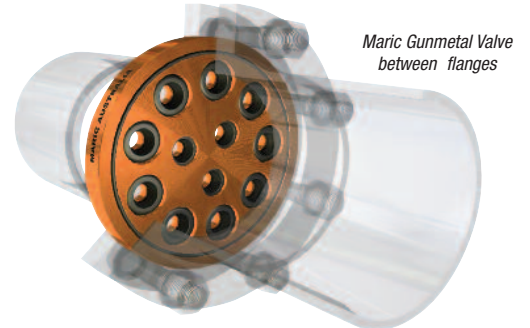

Maric Gunmetal Valve between flanges

its spec. at start-up. At lower flow rates, it has little impact on pump output.

Question: What will the headloss across the Maric valve be?;

Answer: It depends on the flow rate.

I.e, at the valves full rated flow, headloss will be between 140 and 1000 kPa. (for "Precision" spec. valves).

At lower flow rates, (i.e., the duty point), headloss will be less. e.g., 50% of the valves flow = 30 kPa headloss only.



Submersible pump installation

Pumps can be damaged through inadequate head on:

- **Any bore**, where people can unwittingly open up the bores' gate valve in an attempt to increase flow.
- **High draw-down bores**, i.e. a high standing water table at start-up, as compared to a lower level for the normal operating condition.
- **Empty pipe work at start-up**, i.e. lack of, or faulty check valve, or where lines on surface drain empty.
- **Over-pumping beyond the refill rate**, to point of drawing in air or sand.
- **A burst in the pipework.**
- **Pumps with two separate duties:** (A), a tank elevated 50m up a hill, and (B), The other, to feed a dam at the same elevation as the pump. (Inadequate head on the lower elevation duty.)
- **Pumping into a main where pressure is fluctuating.**
- **Rising water tables:** Limiting pump peak flow rate can prevent electric motors from overloading as operating head reduces.
- **Where regulators restrict pumping from a river:** It is a requirement that a non-adjustable flow control device is used.

Key features of Maric Flow Controllers:

- **Constant flow rate:** regardless of pressure.
- **Tamperproof:** Maric valves are non-adjustable, eliminating unauthorised adjustment.
- **Maintenance free, reliable and self-cleaning;** As there are no wearing parts, the valves require no maintenance, adjustment or cleaning during their 20+ year life span.

www.maric.com
Ph: +61 8 8431 2281



Maric Constant Flow Valves

Constant Flow Rate
Regardless of Pressure



Est. 1963

Case Study: Franklin FPS1A-13TS

Using Maric flow control valve for pump protection in a high standing (high draw-down) water table installation.

This pump suits the application at the 85m draw down level, however, it will run off the right hand side of curve with only 20m head against pump at start up resulting in pump and motor damage.

Installation Details

• Pump	Franklin FPS1A-13TS
• Flow Controller	Maric 23 litre per minute Precision
• Pump depth	110m
• Standing water table	20m
• Typical draw down water level	85m
• Max flow allowed (rhs of curve)	1.55m ³ /hr (26.0 lpm)
• or, Min. Head required	43m
• Duty	To fill tank at ground level adjacent borehead

Pump Selected; Franklin FPS1A-13TS

Manufacturers performance curve below indicates flow should not exceed 1.55m³/hr (26L/min).

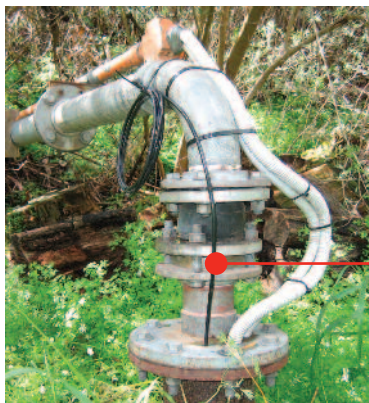
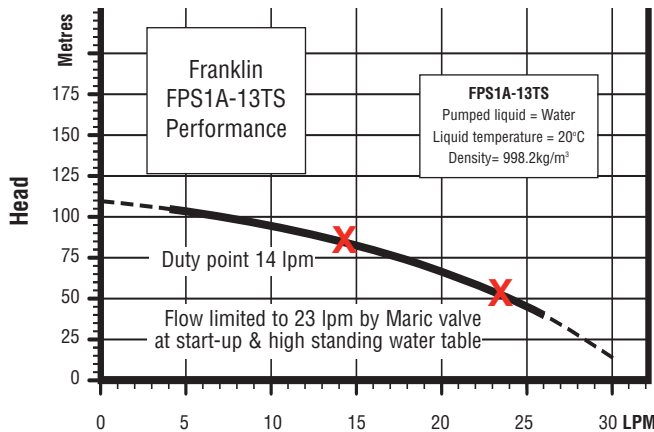

Gunmetal wafer type valve mounted between flanges

Pump Protection Requirement

To limit flow, or add sufficient head, during start-up, to prevent pump and motor damage due to upthrust condition.

Three options available

1, Gate Valve: They are cheap, can be noisy and can also result in a high headloss at the duty point, reducing pump output. As these valves can be adjusted by anyone, they are **not tamperproof**, and are often opened all the way in the endeavour to get maximum flow and can fail due to gate vibrating loose.

2, Pressure Sustaining valve: These are expensive, adjustable, and can result in a potentially high headloss at duty point, reducing pump output. Again, as they are adjustable, they are **not tamperproof**, and are often opened all the way in the endeavour to get maximum flow.

3, Flow Controller: These are the **best solution** for high standing water table, with lower duty point conditions. **They are tamperproof**, inexpensive and result in a low headloss at the duty point as can be seen in the graph below.

Question:

What will the headloss be across the Maric valve and its affect on pump performance at the 85m duty point?

Answer:

Very little. Around 3 metres.

Why?:

At 85 metres drawdown (and resulting head against pump), flow rate will be 0.85m³/hr (14 lpm) only. This is 60% only of the rated flow of the flow controller, and at 60% of flow through the Maric valve, the pressure differential, (or headloss) is around 4 metres only, having little affect on pump output.

Flow Control Valve Performance:

Flow control valve performance curve below indicates 60% of rated flow = 4 metres headloss only (see X).

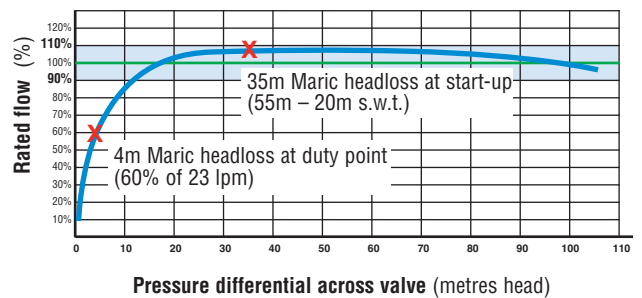

Conclusion:

As in the above application, and many similar cases, the Maric flow control valve is an excellent choice for pump protection, due to its lower headloss, cost effectiveness, long maintenance free life and being **virtually tamperproof**.



Constant Flow Rate
Regardless of Pressure



Est. 1963



WaterMark
Quality Assured

S037.1 L143 SAI Global

Domestic and commercial water savings

Maric flow control valves automatically maintain a fixed, maximum constant flow rate, and are often used to save water in homes, motels and commercial buildings in the following outlets;

- **Domestic Showers & Basins** - Saving water in the home.
- **Showers • Kitchen sinks • Bathroom basins and laundry troughs**
Controlled flow can prevent scolding or freezing, when someone uses too much cold or hot water.
- **Drinking Fountains** - Controlled stream prevents frustration at the drinking fountain.
- **Toilet Cisterns** - Prevents the potential "continuous flush" operation if fill rate is too fast.
- **Water Heaters** - Keeping flow below a pre set maximum ensures gas & electric instantaneous heaters can heat to a sufficiently hot & advertised temperature.

For most domestic applications, the use of kwyflo type valves is recommended for more quiet operation.

Flow control of shower heads is the green thing to do

Save water and costly hot water in the home

Controlled flow in the garden can reduce wastage



www.maric.com

Ph: +61 8 8431 2281



Maric Constant Flow Valves

Constant Flow Rate
Regardless of Pressure



Est. 1963

(Adelaide, Australia 2019)

Maric flow control valves automatically maintain a fixed, maximum constant flow rate, and are often used to save water in homes, motels and commercial buildings in the following outlets;

- Showers • Kitchens Sinks • Bathroom Basins

The following calculations demonstrate how an average home can save \$ 1207.00 (Australian Dollars) per year after installing Maric flow controllers to just the shower alone. The fitting of flow controllers to kitchen and bathroom basins, etc., will further increase savings.

Assumptions:

• Family size	4 people
• 4 x 10 minute showers per day	40 minutes
• Shower consumption without Maric valve	15 litres per minute, x 40 = 600 litres of warm water
• Average ambient water temperature	16° C
• Average shower water temperature	43° C
• Cost of water	1 KiloLitre = \$ 3.37
• Cost of electricity	\$0.219 per unit (1 unit = 1 KiloWatt Hour)
• 1 KiloWatt Hour (KWH) heats 100 litres	8.5° C (this is a known constant)

Water Saving Calculations:

Assume a 7 lpm shower flow controller is installed. 8 lpm will be saved, x 40 minutes = 320 litres per day.
320 x 365 days = 117,000 Litres per year saved.

*117 KiloLitres x \$ 3.37 per KL = **\$394.00 per year saved.***

Electricity Saving Calculations:

Lift in temperature required is 27°C (43°C shower temp, minus 16°C incoming temp)

If 1.0 KWH heats 100L by 8.5° C,
Therefore 1.0 KWH heats 31.5 litres 27° C
Therefore 3714 KWH heats 117 KiloLitres (saving) by 27° C

*3714 KWH x \$0.219 per KWH = **\$813.00 per year saved.***

Total Annual Savings:

Savings per year Water	\$ 394.00
Savings per year Electricity	\$ 813.00
	\$ 1207.00 total annual savings per hotel room or family home in the shower only.

www.maric.com
Ph: +61 8 8431 2281

Further savings will be made by installing valves in the kitchen and bathroom basins also.



Conclusion; If Maric valves retail in Adelaide for around 30 Dollars, it will take less than one month for the valve pay for itself!

Maric Constant Flow Valves

Constant Flow Rate Regardless of Pressure



Est. 1963

(Dubai U.A.E. 2015)

Water Waste Occurs:

- When users are not concerned about waste or the high cost of water –e.g. “House Help”, “Hotel Guests”, “Children”, etc.
- When two or more taps are simultaneously in use and one is closed down, flow rate in the one’s that are open might increase, creating waste.
- When the water pressure in pipes is very high and the water tap would need to be adjusted to reach the desirable flow rate. In this adjustment period considerable amount of water could be wasted.

Maric flow control valves automatically maintain a fixed, maximum constant flow rate, and are often used to save water in homes, hotels and commercial buildings in the following outlets:

- **Bath Showers • Toilet Showers • Kitchens Sinks • Basins • Garden Irrigation**

The following calculations demonstrate how an average home can save Dhs. 1140.00 per year after installing Maric flow controllers to just the shower alone. The fitting of flow controllers to kitchen and bathroom basins, etc., will further increase savings.

Assumptions:

• Family size	4 people
• 4 x 10 minute showers per day	40 minutes
• Average water consumption in shower	15 litres per minute, x 40 = 600 litres, or 159 gallons of warm water
• Average ambient water temperature	25° C
• Average shower water temperature	40° C
• Cost of water & sewerage combined	1.0 U.S. gallon (3.785 litres) = Dhs. 0.041
• Cost of electricity	Dhs. 0.345 per KiloWatt Hour
• 1 KiloWatt Hour (KWH) heats Avg. 100 litres	8.5° C
• Shower water heating required	For approximately half the year only.

Water Saving Calculations:

With a 7 lpm shower flow controller installed, 8 lpm will be saved, x 40 minutes = 320 litres per day. (84 gallons)
84 gallons x 365 days = 30,660 gallons per year saved. (117 Kilolitres)

30,660 gallons @ Dhs. 0.041 per gallon = Dhs. 1257.06 per year saved.

Electricity Saving Calculations:

Lift in temperature required =15°C

If Avg. 100 litres heated 8.5°C = Electric consumption of 1.0 KWH
> 57 litres heated 15.0°C = Electric consumption of 1.0 KWH
therefore 117000 litres heated 15.0°C = Electric consumption of 2050.0 KWH

Assuming water heaters are used for only half the year due to ambient temperature conditions in Dubai
= 2050.0 KWH ÷ 2 = 1025 KWH

1025 KWH x Dhs. 0.345 per KWH = Dhs. 353.00 per year saved.

www.maric.com

Ph: +61 8 8431 2281

Total Annual Savings:

Savings per year Water Dhs. 1257.00
Savings per year Electricity Dhs. 353.00
Dhs.1610.00 (total annual savings per hotel room or family home in the shower only).

Conclusion; Installing Maric Valves in the kitchen, bathroom basins, and toilet showers will demonstrate considerable savings in payment of utility bills and contribute to saving our environment.





AUSTRALIA
Maric Constant
Flow Valves



Valve Selection Guide

- Establishing Part Numbers
- Valve Body Specs
- Control Rubber Type

Introduction

Maric Flow Control Valves are available in many configurations catering for numerous civil and industrial environments. This section makes it easy for users to establish all valve specifications and the part number in three easy steps;

- **Establishing Part Numbers**
- **Selecting Valve Body Types**
- **Selecting Control Rubber Type**

Important: Refer to the Product Data section through-out this process

Note;

To ensure availability of a particular configuration, please refer to the "Product Data" section of this catalogue. It is assumed that the reader already has a desired flow rate in mind and a basic understanding of pipe thread and pipe flange terminology.

All flow control valves are made to order, and are therefore not returnable or suitable for modifying for other flow rates.



Exported
Globally

www.maric.com

V1022



Important:
Refer to the Product Data section through-out this process

Valve Selection Guide

Establishing Part Numbers

- When purchasing a Maric valve, please specify each of the components below. The full description (specification) then condenses into an appropriate part number as illustrated below.

Screwed Type Valves – your 7 step specifying guide

1.	2.	3.	4.	5.	6.	7.
Connection Size	Thread Spec (if applic.) standard BSP No character required	Configuration	Body Material	Control Rubber	Check Valve (if applic) Only avail. in 15 & 25mm, F&M, Stainless Steel If required insert C here Check Valve = C	Flow Rate
6, 10, 15 20, 25, 32 40, 50	If Non-Standard NPT required insert N here	MF, FM, or FF First letter specifies inlet.	Brass, PVC Stainless Steel Other materials on Request	Precision = P Low Pressure = LP High Pressure 1 = N6 High Pressure 2 = N7 EPDM = EP EPDM High Pressure 2 = E7 Viton = V Kwyflo = K Hi Flow = HF	In litres per minute	

Description: No 15 – F&M Brass Precision – 9 lpm

Applicable part number: **15FMBP9**

Other examples;

No.15 F&F PVC Precision 9 lpm	15FFPP9
No.20 F&F S/steel EPDM 36 lpm	20FFSEP36
No.15 F&M S/steel EPDM Flow Control Check 12 lpm	15FMSEPC12
No.25 NPT F&M S/steel Precision Flow Control Check 45 lpm	25NFMSPC45

Wafer Type Valves – your 5 step specifying guide

1.	2.	W	3.	4.	5.
Body Size	Flange Spec (if applic.) Australian - for table D no character req'd. Table E, F Class#14 = C14 Class#16 = C16 Class#21 = C21 American ANSI ANSI300 = A3 ANSI150 = A1 BS4504, DIN, EN & ISO7005 PN10, PN16, PN25 Japanese JIS2220 PN16 = J16 PN10 = J10 PN25 = J25	Specifies Wafer	Body Material	Control Rubber	Flow Rate
25, 32, 40, 50, 65, 80 , 100, 150, 200, 250, 300mm	Brass, PVC Gunmetal Stainless Steel Other materials on Request	Precision = P Low Pressure = LP High Pressure 1 = N6 High Pressure 2 = N7 EPDM = EP EPDM High Pressure 2 = E7 Viton = V Kwyflo = K High Flow = HF	In litres per minute		

Description: No 80 – Wafer PVC Precision 658 lpm

Applicable part number: **80WPP658**

Other examples;

50mm Wafer Brass Precision 342lpm	50WBP342
100mm Wafer PVC Low Pressure 750 lpm	100WPLP750
200mm (Table E) Wafer Gunmetal Precision 4427 lpm	200EWGP4427
40mm (ANSI150) Wafer S/steel EPDM 59lpm	40A1WSEP59

Insert Type Valves – contact your nearest Maric Representative





Important:
Refer to the Product Data section through-out this process

Valve Selection Guide

Valve Body Types

1

Step one:

Connection types: Screwed, Wafer or Insert as determined by installation preferences

Select from the following Body Connection Types:

• For **Screwed type** valves consider:

- Body Size
- Thread type; BSP as standard. NPT is currently available in F&F in stainless bodies. Also other materials and configurations where quantities justify production
- Thread configuration; MF, FM or FF configuration
- Check valve feature if required (available only in No 15 and No 25 stainless steel bodies)



• For **Wafer type (flange mount)** valves consider:

- Body Size
- Flange Specification



• **Insert type**, are designed mostly for either press-fitting into OEM's equipment, or for installation within water authority water meter assemblies. Due to the vast number of meter manufacturers, models and sizes it is best to speak to a Maric representative for assistance in selection of an insert.



2

Step two:

Material options as determined by environment

Select from the following Body Material Options:

- **Screwed;** Brass, UPVC and Stainless Steel
- **Wafer;** Brass, Gunmetal, UPVC and Stainless Steel
- **Insert;** Brass, UPVC and Stainless Steel





Important:
Refer to the Product Data section through-out this process



Valve Selection Guide

Control Rubber Types

Control rubbers, together with the shape of their enclosure, controls the flow rate. Precision Nitrile type are supplied as standard unless otherwise requested.

If installations parameters render standard Precision control rubbers unsuitable, see below for the full range of control rubber types available.



Factors to consider when selecting alternative control rubbers for the valves.

- Maximum pressure differential
- Compatibility with chemical environment
- Operating temperature
- Noise
- Body material compatibility

Rubber Type	Abbreviation	Rubber Material	Pressure Differential Range	Flow Accuracy	Max Temp
Precision (standard)	“P”	Nitrile	140 – 1000 kPa (1.4 – 10 bar)	+/-10%	60C
Applications - Supplied as standard, they offer the best flow rate accuracy and tolerate a wide range of chemical environments, making them suitable for most mains pressure, pumping, industrial, and water treatment applications. This product complies with the WaterMark license and AS4020 Potable Water requirement.					
Kwyflo	“K”	Nitrile	140 – 1000 kPa (1.4 – 10 bar)	+/-20%	60C
Applications - For applications where noise must be minimised. Originally used for domestic water saving applications, they are also suited to industrial applications. Not available in Stainless Steel bodies.					
Low Pressure	“LP”	Nitrile	45 – 500 kPa (0.45 – 5 bar)	+/-20%	60C
Applications - Used where the installation demands a low headloss flow controller. NOTE: Only Available in No 15 Series Rubbers from 5.0 lpm upwards					
High Pressure (1)	“N6”	Nitrile	140 – 1500 kPa (1.4 – 15 bar)	+/-20%	60C
Applications - Used where installation pressures exceed that which Precision valves will handle. Not compatible with PVC bodies.					
High Pressure (2)	“N7”	Nitrile	170 – 2000 kPa (1.7 – 20 bar)	+/-20%	60C
Applications - Used where installation pressures exceed that which Precision and High Pressure 1 valves will handle. Compatible with Stainless Steel bodies only.					
High Flow	“HF”	Nitrile	140 – 700 kPa (1.4 – 7 bar)	varies	60C
Applications - Where available, allow for higher than standard maximum flow rates for body size.					
EPDM	“EP”	EPDM	140 – 1500 kPa (1.4 – 15 bar)	+/-20%	100C
Applications - For handling higher temperatures and pressures than standard Precision nitrile. They are also suitable in a caustic environment which makes them ideal for the alumina industry.					
EPDM High Pressure 2	“E7”	EPDM	170 – 2000 kPa (1.7 – 20 bar)	+/-20%	100C
Applications - For handling higher temperatures and pressures than standard nitrile and EPDM. They are also suitable in a caustic environment which makes them ideal for the alumina industry. Compatible with Stainless Steel bodies only.					
Viton	“V”	Viton	140 – 1000 kPa (1.4 – 10 bar)	+/-20%	200C
Applications - For where temperatures above 100 degrees Celsius, and below 200 degrees Celsius are encountered. Viton is also the preferred material in chemical environments where both Nitrile or EPDM control rubbers are unsuitable.					



AUSTRALIA
Maric Constant
Flow Valves



Product Data

Screwed Valves

Brass and Chrome

PVC

Stainless Steel

Flow Control Check Valves - 15mm

Flow Control Check Valves - 25mm

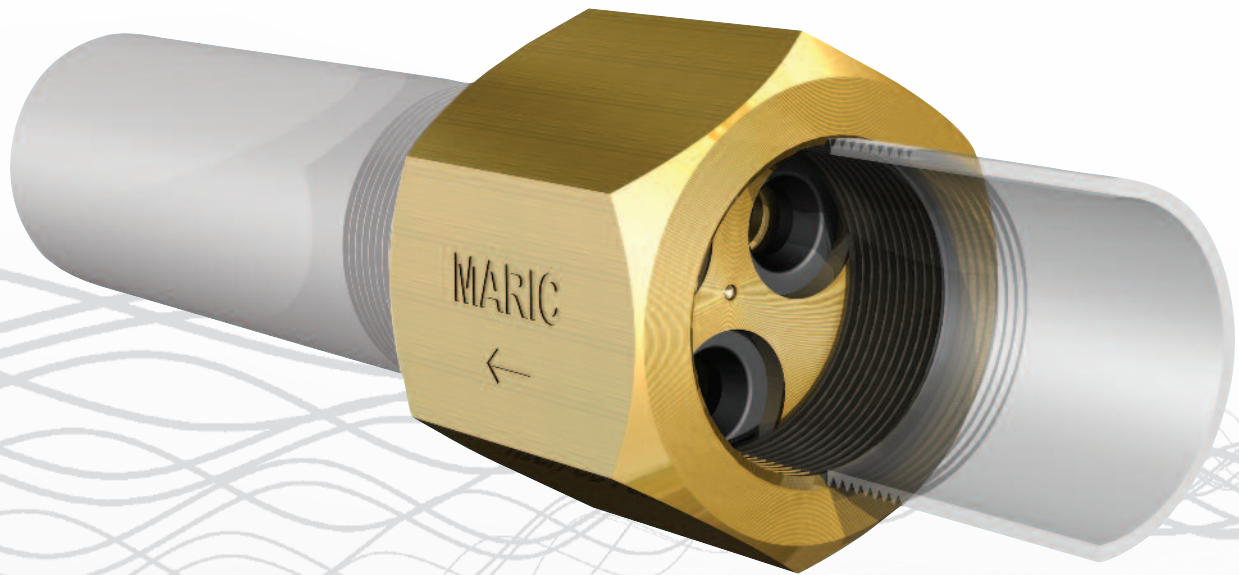

Exported
Globally

www.maric.com

V1022

Maric Constant Flow Valves

Constant Flow Rate Regardless of Pressure



Est. 1963

Availability & Specifications – Maric Flow Control Valves

Body Sizes	Configurations <i>First letter specifies inlet</i>	Flow Rate Availability <i>See all Available Flow Rates below</i>
6mm (1/4")	F&F	from 0.2 to 9 l/m
10mm	F&F	from 0.2 to 9 l/m
15mm	F&F, M&F, F&M	from 0.2 to 23 l/m
20mm	F&F, M&F, F&M	from 0.2 to 59 l/m
25mm	F&F, M&F, F&M	from 0.4 to 114 l/m
32mm	F&F	from 15 to 114 l/m
40mm	F&F	from 15 to 233 l/m
50mm	F&F	from 15 to 342 l/m



Dimensions & Weights

Nominal size	1/4"	10	15	20	25	32	40	50
A/F Dimension "A"	18.0	22.0	25.4	31.8	40.0	50.8	57.0	70.0
FF Body Length "B"	32.0	33.1	41.8	47.9	58.0	66.2	66.2	74.8
MF Body Length "C"	-	15.0	23.2	30.8	39.7	-	-	-
FM Body Length "D"	18.4	15.0	23.2	28.6	36.4	-	-	-
Approx Weight Kg	0.06	0.07	0.1	0.18	0.3	0.6	0.8	1.3-2.2

Standard Performance

Pressure Differential Range
Flow Rate Accuracy
Headloss
Available Flow Rates
 (litres/min)

Unless otherwise specified, **standard** Nitrile "**Precision**" type control rubbers are fitted giving the valve the following standard performance; (Refer also to available; Product Data – Control Rubbers – Precision)

140 – 1000 kPa with Precision Rubbers fitted. (Higher DP options available)

+/- 10%

140 kPa at rated flow. (At lower than rated flows headloss reduces significantly.)

.2 / .25 / .3 / .35 / .4 / .45 / .5 / .55 / .63 / .7 / .8 / .9 / 1.0 / 1.1 / 1.2 / 1.3 / 1.5 / 1.6 / 1.8 / 2.0 / **2.3** / 2.5 / **2.8** / 3.0 / 3.2 / **3.5** / 4.0 / **4.5** / 5.0 / 5.5 / 6.3 / **7.0** / 8.0 / **9.0** / 10 / **11** / 12 / **13** / 15 / **16** / 18 / **20** / 23 / **25** / 28 / **32** / 36 / **41** / 45 / **49** / 54 / **59** / 66 / 73 / 82 / 91 / 102 / 114 / 125 / 138 / 150 / 162 / 180 / 199 / 216 / 233 lpm up to 342 lpm Kwyflo flow rate options, (quiet design) are limited to the flows listed in **underlined bold type**

Materials

Body "DR" Brass to AS1562 alloy 352 (plus chrome plating if applicable)
 Chrome plated valves are available in most 15, 20 & 25mm body sizes

Quality & Construction

Threads Valves comply to WaterMark Technical Standards WMTS-037.1 and AS 4020
 BSPT to AS ISO 7.1-2008 Male Series R, Female RP
 NPT available for minimum order quantities.

Max Pressure Differential

1500 kPa (for N6 and EP rubbers only)

Max Hydrostatic Pressure

6000 kPa

Max Temperature

60°C for Nitrile control rubbers, 100°C for EPDM

Compatible Control Rubbers

Standard Precision P (Non Standard LP, N6, EP, V, K, HF)

Specifying valves

When ordering these valves, please be sure to specify;

- Body size • Thread configuration • Body material
- Control rubber material and pressure differential range - if other than Precision
- Flow Rate



www.maric.com
 Ph: +61 8 8431 2281



Constant Flow Rate Regardless of Pressure



Est. 1963

Availability & Specifications – Maric Flow Control Valves

Body Sizes	Configurations	Flow Rate Availability
6mm (1/4")	F&F	from 0.15 to 9 l/m
15mm	F&F	from 0.15 to 23 l/m
20mm	F&F	from 0.15 to 59 l/m
25mm	F&F	from 0.4 to 114 l/m
32mm	F&F	from 15 to 114 l/m
40mm	F&F	from 15 to 233 l/m
50mm	F&F	from 15 to 342 l/m

See all Available Flow Rates below

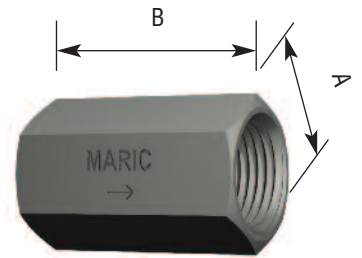

F&F only

Dimensions & Weights

Nominal size	1/4"	15	20	25	32	40	50
A/F Dimension "A"	23.0	32.0	40.0	46.0	56.0	71.0	86.0
FF Body Length "B"	32.0	41.8	47.9	58.0	74.8	74.8	80.8
Approx Weight Kg	0.02	0.04	0.06	0.09	0.15	0.28	0.46



Standard Performance

- Pressure Differential Range
- Flow Rate Accuracy
- Headloss
- Available Flow Rates (litres/min)

Unless otherwise specified, **standard** Nitrile "Precision" type control rubbers are fitted giving the valve the following standard performance; (Refer also to available; Product Data – Control Rubbers – Precision)

140 – 1000 kPa
 +/- 10%
 140 kPa at rated flow. (At lower than rated flows headloss reduces significantly.)
 .15 / .2 / .25 / .3 / .35 / .4 / .45 / .5 / .55 / .63 / .7 / .8 / .9 / 1.0 / 1.1 / 1.2 / 1.3 / 1.5 / 1.6 / 1.8 / 2.0 / **2.3** / 2.5 / **2.8** / 3.0 / 3.2 / **3.5** / 4.0 / **4.5** / 5.0 / 5.5 / 6.3 / **7.0** / 8.0 / **9.0** / 10 / **11** / 12 / **13** / 15 / **16** / 18 / **20** / 23 / **25** / 28 / **32** / 36 / **41** / 45 / **49** / 54 / **59** / 66 / 73 / 82 / 91 / 102 / 114 / 125 / 138 / 150 / 162 / 180 / 199 / 216 / 233 lpm up to 342 lpm
 Kwiflo flow rate options, (quiet design) are limited to the flows listed in **underlined bold type**

Materials	Body	UPVC compliant with AS4020 drinking water requirements
Quality & Construction	Threads	Valves comply to WaterMark Technical Standards WMTS-037.1 and AS 4020 BSP to AS ISO 7.1-2008 Series RP (Parallel) NPT available for minimum order quantities.
Max Pressure Differential		1000 kPa, or limited by Control Rubber type
Max Hydrostatic Pressure		3000 kPa
Max Temperature		50°C
Compatible Control Rubbers		Standard Precision P (Non Standard LP, EP, V, K, HF)
Valve Body Length		Maximum length is shown. Lower Flow rates will change the valve body length and the valve will be slightly shorter
Installation		Maximum recommended tightness is hand-tight plus a quarter of a turn

Specifying valves

When ordering these valves, please be sure to specify;

- Body size • Thread configuration • Body material
- Control rubber material and pressure differential range - if other than Precision
- Flow Rate

www.maric.com
Ph: +61 8 8431 2281





Product Data Stainless Steel Screwed Valves

Availability & Specifications – Maric Flow Control Valves

Body Sizes	BSP Configurations <i>First letter specifies inlet</i>	NPT Configurations <i>First letter specifies inlet</i>	Flow Rate Availability <i>See all Available Flow Rates below</i>
6x3mm (1/4" x 1/8")	F&M	-	from 0.20 to 9 l/m
6mm (1/4")	F&F, F&M	F&F	from 0.20 to 9 l/m
10mm	M&F	F&F	from 0.20 to 9 l/m
15mm	F&F, M&F, F&M	F&F	from 0.20 to 23 l/m
20mm	F&F	F&F	from 0.20 to 59 l/m
25mm	F&F, M&F, F&M	F&F	from 0.4 to 114 l/m
32mm	F&F	F&F	from 15 to 114 l/m
40mm	F&F	F&F	from 15 to 233 l/m
50mm	F&F	F&F	from 15 to 233 l/m

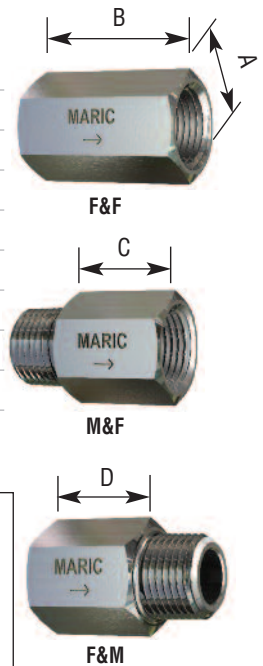

Dimensions & Weights

Nominal size	1/4" x 1/8"	1/4"	10	15	20	25	32	40	50
A/F Dimension "A"	18.0	18.0	22.0	25.4	31.8	40.0	57.0	57.0	70.0
FF Body Length "B"	-	32.0	-	41.8	47.9	58.0	66.2	66.2	74.8
MF Body Length "C"	-	-	15.0	23.2	-	39.7	-	-	-
FM Body Length "D"	18.6	18.6	-	23.2	-	36.4	-	-	-
NPT (F&F only)	-	32.8	33.1	42.0	43.1	57.0	61.6	61.6	62.4
Approx Weight Kg	0.03	0.04	0.05	0.1	0.18	0.22	0.83	0.7	1.0

Standard Performance

Pressure Differential Range
Headloss
Flow Rate Accuracy
Available Flow Rates
 (litres/min)

Unless otherwise specified, **standard** Nitrile "Precision" type control rubbers are fitted giving the valve the following standard performance; (Refer also to available; Product Data – Control Rubbers – Precision)

140 – 1000 kPa (Higher DP options available)

140 kPa at rated flow. (At lower than rated flows headloss reduces significantly.)

+/- 10%

.2/.25 / .3 / .35 / .4 / .45 / .5 / .55 / .63 / .7 / .8 / .9 / 1.0 / 1.1 / 1.2 / 1.3 / 1.5 / 1.6 / 1.8 / 2.0 / **2.3** / 2.5 / **2.8** / 3.0 / 3.2 / **3.5** / 4.0 / **4.5** / 5.0 / 5.5 / 6.3 / **7.0** / 8.0 / **9.0** / 10 / **11** / 12 / **13** / 15 / **16** / 18 / **20** / 23 / **25** / 28 / **32** / 36 / **41** / 45 / **49** / 54 / **59** / 66 / 73 / 82 / 91 / 102 / 114 / 125 / 138 / 150 / 162 / 180 / 199 / 216 / 233 lpm

Materials	Body	316 Stainless Steel to ASTM484/A276
	Threads, BSPT	BSPT to AS ISO 7.1-2008 Male Series R, Female RP (Standard)
	Threads, NPT	NPT to ANSI/ASME B1.20.1 Female NPSC, Male NPT
	Max Pressure Differential	2000 kPa (for N7 & E7 rubbers only)
	Max Hydrostatic Pressure	6000 kPa
	Max Temperature	60°C for Nitrile control rubbers, 100°C for EPDM, 200°C for Viton
	Compatible Control Rubbers	Standard Precision P (Non Standard LP, N6, N7, EP, E7, V, HF)

Specifying valves

When ordering these valves, please be sure to specify;

- Body size • (NPT if applicable) • Thread configuration • Body material
- Control rubber material and pressure differential range - if other than Precision
- Flow Rate



Maric Constant Flow Valves

Constant Flow Rate Regardless of Pressure



Est. 1963

Application

For providing the centrifugal pumping industry with a constant glandwater flow rate to pump glands, - with backflow prevention. A constant pre-set maximum flow rate to centrifugal pump glands can be achieved irrespective of fluctuating gland-water supply pressure, gland condition, or centrifugal pump discharge pressure.

Benefits

- A constant supply of glandwater to the gland, ensures the life of expensive pump seals are maximised.
- Can ensure that the slurry will not be unnecessarily diluted.
- Prevents one centrifugal pump from robbing all the available gland water in the event of its failure, which could result in the simultaneous failure of all other glands supplied from the same water supply.
- Minimise wastage of available water supplies

Features

- Constant glandwater flow rate
- Back-flow prevention
- High pressure and high temperature handling
- Corrosion and scale resistant assembly

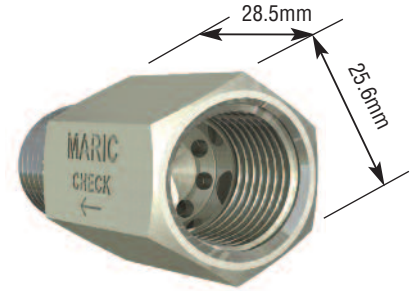

Non-Return Feature. The maintenance free design of the Maric valve uses the flow control rubber as the flexible sealing component in the non-return mechanism. The flexing of the control rubber under normal operating conditions prevents scale build-up on the rubbers surface, which ensures a reliable seal, even after extended periods of no reverse pressure.

Standard Performance

Unless otherwise specified, **EP type EPDM** control rubbers are fitted giving the valve the following standard performance;

Pressure Differential Range	140 – 1500 kPa
Headloss	140 kPa at rated flow. (At lower than rated flows headloss, reduces significantly.)
Flow Rate Accuracy	+/- 20%
Available Flow Rates (litres/min)	.4 / .45 / .5 / .55 / .63 / .7 / .8 / .9 / 1.0 / 1.1 / 1.2 / 1.3 / 1.5 / 1.6 / 1.8 / 2.0 / 2.3 / 2.5 / 2.8 / 3.0 / 3.2 / 3.5 / 4.0 / 4.5 / 5.0 / 5.5 / 6.3 / 7.0 / 8.0 / 9.0 / 10 / 11 / 12 / 13 / 15 / 16 / 18 lpm
Check Valve Operation	Closed when reverse pressure of 70 kPa exists
Body Material	303 Stainless Steel to ASTM484/A582
Thread Configuration	F&M, Female inlet (parallel), Male outlet,(tapered)
Threads, BSPT	15mm (1/2") BSPT to AS1722.1 Female Series RP, Male Series R
Threads, NPT (non-standard)	15mm (1/2") NPT to ANSI/ASME B1.20.1, Female NPSC, Male NPT
Max Hydrostatic Pressure	6000 kPa
Temperature Range	0 - 100 degrees C.

Non-Standard Specifications

High pressure 2, "E7", 170 – 2000 kPa. is also available. Alternative flow rates apply

Performance Curve Options – Maric, No 15 Flow Control Check Valve

EP = 140 - 1500 kPa, High Pressure 2 (E7) = 170 - 2000 kPa

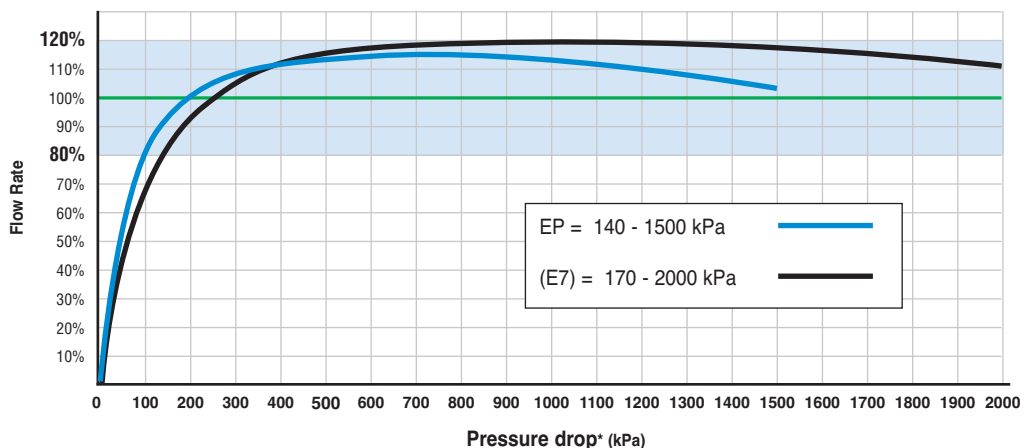

www.maric.com
Ph: +61 8 8431 2281



Please Specify When Ordering:

Body Size	Configuration	Body Material	Control Rubber	Check	Flow Rate
15mm	F&M	Stainless	EP (or E7)	C	0.4 to 18 lpm

Example Part Number for 18 lpm;

15 FM S EP C 18

(Add N here for NPT if required)

Maric Constant Flow Valves

Constant Flow Rate Regardless of Pressure



Est. 1963

Application

For providing the centrifugal pumping industry with a constant glandwater flow rate to pump glands, with backflow prevention. A constant pre-set maximum flow rate to centrifugal pump glands can be achieved irrespective of fluctuating gland-water supply pressure, gland condition, or centrifugal pump discharge pressure.

Benefits

- A constant supply of glandwater to the gland, ensures the life of expensive pump seals are maximised.
- Can ensure that the slurry will not be unnecessarily diluted.
- Prevents one centrifugal pump from robbing all the available gland water in the event of its failure, which could result in the simultaneous failure of all other glands supplied from the same water supply.
- Minimise wastage of available water supplies

Features

- Constant glandwater flow rate
- Back-flow prevention
- High pressure and high temperature handling
- Corrosion and scale resistant assembly



Non-Return Feature. The maintenance free design of the Maric valve uses the flow control rubber as the flexible sealing component in the non-return mechanism. The flexing of the control rubber under normal operating conditions prevents scale build-up on the rubbers surface, which ensures a reliable seal, even after extended periods of no reverse pressure.

Standard Performance

Pressure Differential Range

Unless otherwise specified, **standard** Nitrile “**Precision**” type control rubbers are fitted giving the valve the following standard performance;

Headloss

140 kPa at rated flow. (At lower than rated flows, headloss reduces significantly.)

Flow Rate Accuracy

+/- 10%

Available (Precision) Flow Rates

15 / 16 / 18 / 20 / 23 / 25 / 28 / 32 / 36 / 41 / 45 / 49 / 54 / 59 / 66 lpm

(litres/min)

For flow rates in other control rubber types - contact a Maric rep.

Check Valve Operation

Closed when reverse pressure of 70 kPa exists

Body Material

316 Stainless Steel to ASTM484/A276

Thread Configuration

F&M, Female inlet (parallel), Male outlet, (tapered)

Threads, BSPT

25mm (1”) BSPT to AS1722.1 Female Series RP, Male Series R

Threads, NPT (non-standard)

25mm (1”) NPT to ANSI/ASME B1.20. Female NPSC, Male NPT

Max Hydrostatic Pressure

6000 kPa

Temperature Range

0 - 60 degrees C. (100°C for non-standard EPDM control rubbers)

Non-Standard Specifications

Control rubber material EPDM for higher temp and / or caustic handling

Pressure differential ranges 140 - 1500 kPa., & 170 - 2000 kPa. In EPDM or Nitrile - Refer to “How to Specify Maric Valves” Alternative flow rates apply. Flow accuracy is +/- 20%

Performance graph for standard valves with control rubber type, Precision

*Pressure drop is the difference between inlet and outlet pressure across the valve.

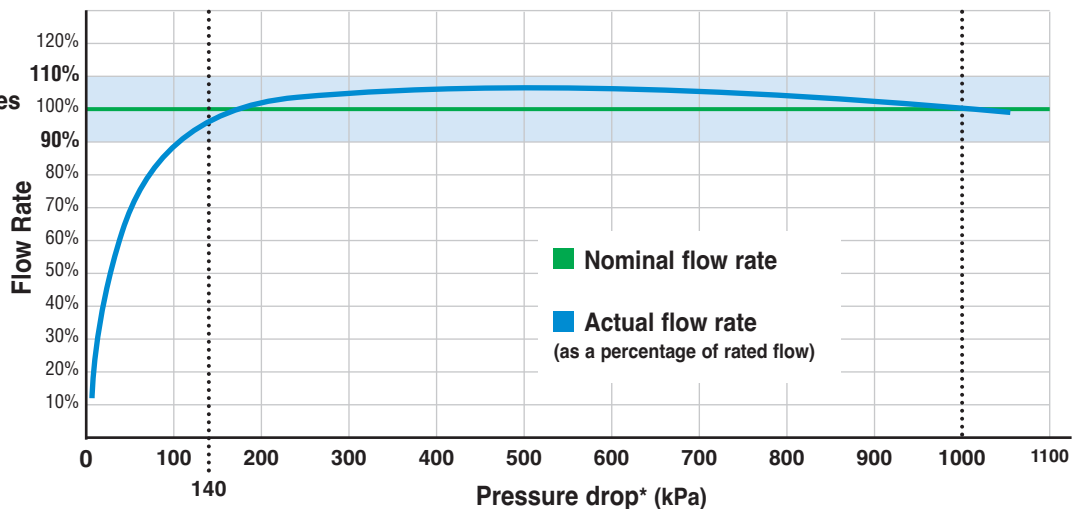

www.maric.com

Ph: +61 8 8431 2281



Please Specify When Ordering: Body Size **25mm** Configuration **F&M** Body Material **Stainless** Control Rubber **Precision (or other)** Check **C** Flow Rate **18 to 66 lpm**

Options / Description

Example Part Number for 66 lpm; **25 FM S P C 66**

(Add **N** here for NPT if required)



AUSTRALIA
Maric Constant
Flow Valves



Product Data

Wafer Type Valves

Brass

Gunmetal

PVC

Stainless Steel - Table D

Stainless Steel -ANSI/ASME

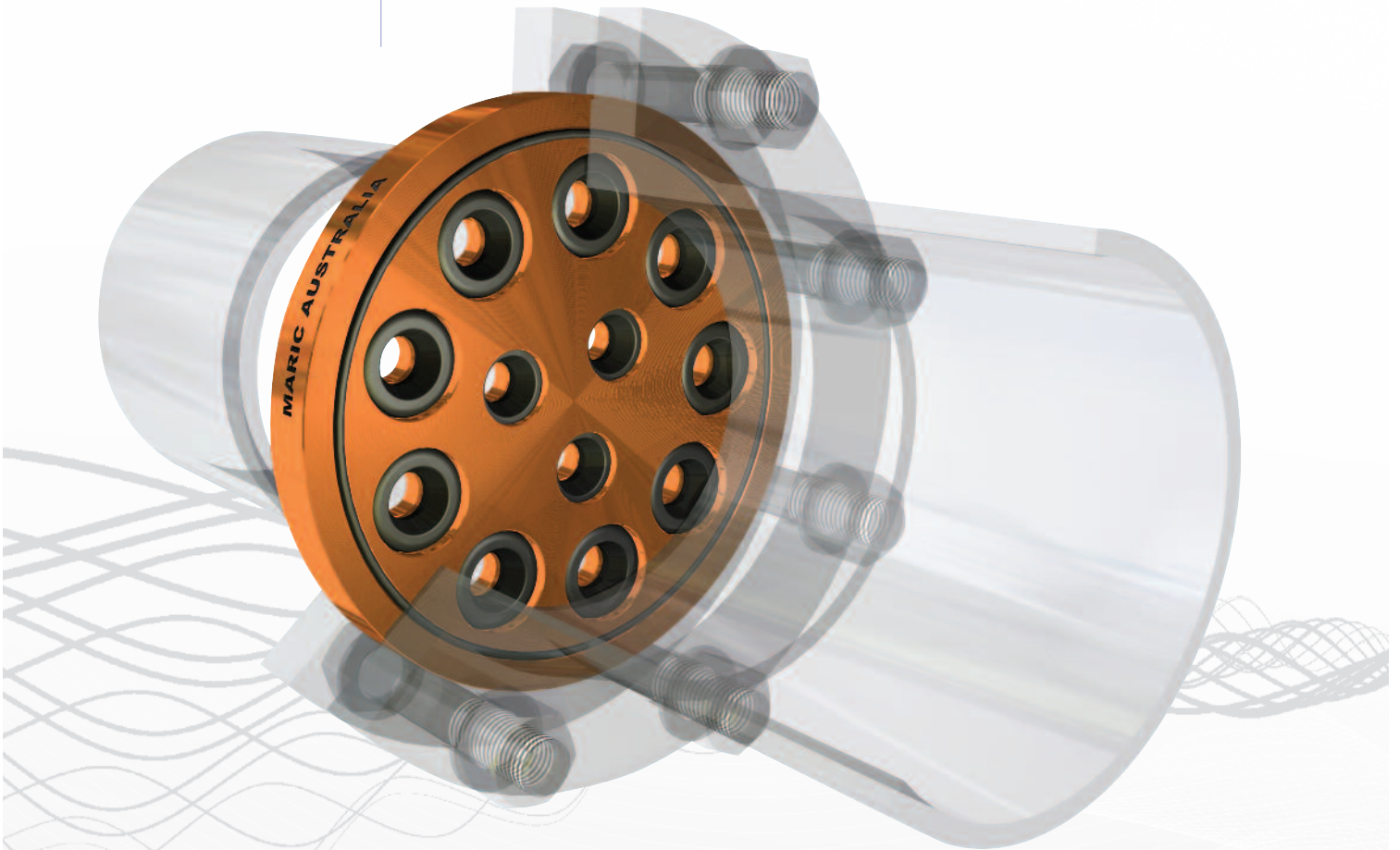

Exported
Globally

www.maric.com

V1022

Maric Constant Flow Valves

Constant Flow Rate Regardless of Pressure



Est. 1963

Availability & Specifications – Maric Flow Control Valves

Designed for mounting between Table “D” pipe flanges.

Sizes	flow rate ranges avail.	standard no. of control rubbers
25mm	from 0.4 to 114 l/m	1
32mm	from 15 to 114 l/m	1
40mm	from 15 to 233 l/m	1
50mm	from 15 to 342 l/m	1 – 3



Dimensions & Weights

Nominal size	25	32	40	50
Diameter	71.0	75.0	86.0	98.0
Thickness	22.0	22.0	22.0	22.0
Approx Weight Kg	0.6	0.8	0.9	1.2

Standard Performance

Pressure Differential Range
Flow Rate Accuracy
Headloss
Available Flow Rates

Unless otherwise specified, **standard** Nitrile “**Precision**” type control rubbers are fitted giving the valve the following standard performance; (Refer also to available; Product Data – Control Rubbers – Precision)

140 – 1000 kPa (Higher DP options available)

+/- 10%

140 kPa at rated flow. (At lower than rated flows headloss reduces significantly.)

.4 / .45 / .5 / .55 / .63 / .7 / .8 / .9 / 1.0 / 1.1 / 1.2 / 1.3 / 1.5 / 1.6 / 1.8 / 2.0 / 2.3 / 2.5 / 2.8 / 3.2 / 3.0 / 3.5 / 4.0 / 4.5 / 5.0 / 5.5 / 6.3 / 7.0 / 8.0 / 9.0 / 10 / 11 / 12 / 13 / 15 / 16 / 18 / 20 / 23 / 25 / 28 / 32 / 36 / 41 / 45 / 49 / 54 / 59 / 66 / 73 / 82 / 91 / 102 / 114 / 125 / 138 / 150 / 162 / 180 / 199 / 216 / 233 lpm up to 342 lpm

Materials **Body**
Sealing O’Rings

“DR” Brass to AS1567 alloy 352
Nitrile, potable water approved to AS4020 or EPDM or Viton if applicable

Quality & Construction
Flange Specification

Valves comply to WaterMark Technical Standards WMTS-037.1 and AS 4020
Suits standard table “D” flanges to AS2129 and AS4087 Class 14
Alternative specs are available - Refer to Valve Selection Guide for additional info.
Standard Wafers are not full flange type i.e. flange bolts locate wafer concentrically and remain visible when viewing assembly. Wafers are fitted with an o’ring in each face for sealing against smooth flat faced flanges. Gaskets will however be required where grooved, raised or rough cast face flanges are used.
PVC and Poly Stub Flanges note; Due to smaller I.D. of these flanges/pipes, optional spacers are often required to prevent restriction.

Max Pressure Differential
Max Hydrostatic Pressure
Max Temperature
Compatible Control Rubbers

1500 kPa (for N6 and EP rubbers only)
6000 kPa
60°C for Nitrile control rubbers, 100°C for EPDM
Standard Precision P (Non Standard LP, N6, EP, K, V, HF)

Specifying valves

When ordering these valves, please be sure to specify;

- Body size
- Flange specification (if other than Table D)
- Body material
- Control rubber material and pressure differential range (if other than Precision)
- Flow Rate

www.maric.com
Ph: +61 8 8431 2281



Maric Constant Flow Valves

Constant Flow Rate Regardless of Pressure



Est. 1963

Availability & Specifications – Maric Flow Control Valves

Designed for mounting between Table “D” pipe flanges.

Sizes	flow rate ranges avail.	standard no. of control rubbers
50mm	from 15 to 342 l/m	1 – 3
65mm	from 15 to 456 l/m	4
80mm	from 15 to 699 l/m	3
100mm	from 15 to 1279 l/m	6
150mm	from 15 to 2320 l/m	12
200mm	from 114 to 4427 l/m	19
250mm	from 114 to 6058 l/m	26
300mm	from 114 to 8854 l/m	38



Dimensions & Weights

Nominal size	50	65	80	100	150	200	250	300
Diameter	98.0	111.0	130.0	162.0	219.0	276.0	336.0	386.0
Thickness	22.0	22.0	22.0	24.0	28.0	35.0	40.0	50.0
Approx Weight Kg	1.2	1.3	1.9	3.1	7.0	13.0	25.0	45.0

Standard Performance

Pressure Differential Range
Flow Rate Accuracy
Headloss
Available Flow Rates

Unless otherwise specified, **standard** Nitrile “**Precision**” type control rubbers are fitted giving the valve the following standard performance; (Refer also to available; Product Data – Control Rubbers – Precision)
 140 – 1000 kPa (Higher DP options available)
 +/- 10%
 140 kPa at rated flow. (At lower than rated flows headloss reduces significantly.)
 15 / 16 / 18 / 20 / 23 / 25 / 28 / 32 / 36 / 41 / 45 / 49 / 54 / 59 / 66 / 73 / 82 / 91 / 102 / 114 / 125 / 138 / 150 / 162 / 180 / 199 / 216 / 233 lpm up to 8854 lpm

Materials

Body
Sealing O’Rings

LG2 or LG4 to BS1400
 Nitrile, potable water approved to AS4020 or EPDM or Viton if applicable

Flange Specification

Suits standard table “D” flanges to AS2129 and AS4087 Class 14
 Alternative specs are available - Refer to Valve Selection Guide for additional info.
 Standard Wafers are not full flange type i.e. flange bolts locate wafer concentrically and remain visible when viewing assembly. Wafers are fitted with an o’ring in each face for sealing against smooth flat faced flanges. Gaskets will however be required where grooved, raised or rough cast face flanges are used.
 PVC and Poly Stub Flanges note; Due to smaller I.D. of these flanges/pipes, optional spacers are often required to prevent restriction.

Max Pressure Differential
Max Hydrostatic Pressure
Max Temperature
Compatible Control Rubbers

1500 kPa (for N6 and EP rubbers only)
 6000 kPa
 60°C for Nitrile control rubbers, 100°C for EPDM
 Standard Precision P (Non Standard LP, N6, EP, K, V, HF)

www.maric.com
 Ph: +61 8 8431 2281

Specifying valves

When ordering these valves, please be sure to specify;

- Body size
- Flange specification (if other than Table D)
- Body material
- Control rubber material and pressure differential range (if other than Precision)
- Flow Rate



Maric Constant Flow Valves

Constant Flow Rate Regardless of Pressure



Est. 1963

Availability & Specifications – Maric Flow Control Valves

Designed for mounting between Table “D” pipe flanges.

Sizes	flow rate ranges avail.	standard no. of control rubbers
25mm	from 0.4 to 114 l/m	1
32mm	from 15 to 114 l/m	1
40mm	from 15 to 233 l/m	1
50mm	from 15 to 342 l/m	1 – 3
65mm	from 15 to 456 l/m	4
80mm	from 15 to 699 l/m	3
100mm	from 15 to 1279 l/m	6
150mm	from 15 to 2320 l/m	12
200mm	from 114 to 4427 l/m	19
250mm	from 114 to 6058 l/m	26
300mm	from 114 to 8854 l/m	38



Dimensions & Weights

Nominal size	25	32	40	50	65	80	100	150	200	250	300
Diameter	71.0	75.0	86.0	98.0	111.0	130.0	162.0	219.0	276.0	336.0	386.0
Thickness	24.0	24.0	24.0	24.0	24.0	24.0	39.5	39.5	49.0	80.0	100.0
Approx Weight Kg	0.12	0.13	0.15	0.23	0.24	0.37	0.93	1.0	2.7	9.0	13.0

Standard Performance

Pressure Differential Range
Flow Rate Accuracy
Headloss
Available Flow Rates

Unless otherwise specified, **standard** Nitrile “**Precision**” type control rubbers are fitted giving the valve the following standard performance; (Refer also to available; Product Data – Control Rubbers – Precision)

140 – 1000 kPa
 +/- 10%
 140 kPa at rated flow. (At lower than rated flows headloss reduces significantly.)
 .4 / .45 / .5 / .55 / .63 / .7 / .8 / .9 / 1.0 / 1.1 / 1.2 / 1.3 / 1.5 / 1.6 / 1.8 / 2.0 / 2.3 / 2.5 / 3.0 / 2.8 / 3.2 / 3.5 / 4.0 / 4.5 / 5.0 / 5.5 / 6.3 / 7.0 / 8.0 / 9.0 / 10 / 11 / 12 / 13 / 15 / 16 / 18 / 20 / 23 / 25 / 28 / 32 / 36 / 41 / 45 / 49 / 54 / 59 / 66 / 73 / 82 / 91 / 102 / 114 / 125 / 138 / 150 / 162 / 180 / 199 / 216 / 233 lpm up to 8854 lpm

Materials **Body**
 Sealing O’Rings

Grey UPVC, Special grade to suit potable water requirements to AS4020
 Nitrile, potable water approved to AS4020 or EPDM or Viton if applicable

Quality & Construction
Flange Specification

Valves comply to WaterMark Technical Standards WMTS-037.1 and AS 4020
 Suits standard table “D” flanges to AS2129 and AS4087 Class 14
 Alternative specs are available - Refer to Valve Selection Guide for additional info.
 Standard Wafers are not full flange type i.e. flange bolts locate wafer concentrically and remain visible when viewing assembly. Wafers are fitted with an o’ring in each face for sealing against smooth flat faced flanges. Gaskets will however be required where grooved, raised or rough cast face flanges are used.
 PVC and Poly Stub Flanges note; Due to smaller I.D. of these flanges/pipes, optional spacers are often required to prevent restriction.

Max Pressure Differential
Max Hydrostatic Pressure
Max Temperature
Compatible Control Rubbers

1000 kPa or limited by Control Rubber type
 3000 kPa
 50°C
 Standard Precision P (Non Standard LP, EP, K, V, HF)

Specifying valves

When ordering these valves, please be sure to specify;

- Body size
- Flange specification (if other than Table D)
- Body material
- Control rubber material and pressure differential range (if other than Precision)
- Flow Rate

www.maric.com
 Ph: +61 8 8431 2281



Maric Constant Flow Valves

Constant Flow Rate Regardless of Pressure



Est. 1963

Availability & Specifications – Maric Flow Control Valves

Designed for mounting between Table “D” pipe flanges.

Sizes	flow rate ranges avail.	standard no. of control rubbers
25mm	from 0.4 to 114 l/m	1
32mm	from 15 to 114 l/m	1
40mm	from 15 to 233 l/m	1
50mm	from 15 to 342 l/m	1 – 3
65mm	from 15 to 456 l/m	4
80mm	from 15 to 699 l/m	3
100mm	from 15 to 1279 l/m	6
150mm	from 15 to 2320 l/m	12
200mm	from 114 to 4427 l/m	19
250mm	from 114 to 6058 l/m	26
300mm	from 114 to 8854 l/m	38



Dimensions & Weights

Nominal size	25	32	40	50	65	80	100	150	200	250	300
Diameter	71.0	75.0	86.0	98.0	111.0	130.0	162.0	219.0	276.0	336.0	386.0
Thickness	22.0	22.0	22.0	22.0	22.0	22.0	24.0	24.0	28.0	32.0	40.0
Approx Weight Kg	0.6	0.7	0.9	1.2	1.2	1.6	2.7	5.0	11.0	19.0	31.0

Standard Performance

Pressure Differential Range
Flow Rate Accuracy
Headloss
Available Flow Rates

Unless otherwise specified, **standard** Nitrile “**Precision**” type control rubbers are fitted giving the valve the following standard performance; (Refer also to available; Product Data – Control Rubbers – Precision)

140 – 1000 kPa (Higher DP options available)

+/- 10%

140 kPa at rated flow. (At lower than rated flows headloss reduces significantly.)

.4 / .45 / .5 / .55 / .63 / .7 / .8 / .9 / 1.0 / 1.1 / 1.2 / 1.3 / 1.5 / 1.6 / 1.8 / 2.0 / 2.3 / 2.5 / 2.8 / 3.0 / 3.2 / 3.5 / 4.0 / 4.5 / 5.0 / 5.5 / 6.3 / 7.0 / 8.0 / 9.0 / 10 / 11 / 12 / 13 / 15 / 16 / 18 / 20 / 23 / 25 / 28 / 32 / 36 / 41 / 45 / 49 / 54 / 59 / 66 / 73 / 82 / 91 / 102 / 114 / 125 / 138 / 150 / 162 / 180 / 199 / 216 / 233 lpm up to 8854 lpm

Materials

Body
Sealing O’Rings

316 Stainless Steel to ASTM484/A276
 Nitrile, potable water approved to AS4020 or EPDM or Viton if applicable

Flange Specification

Suits standard table “D” flanges to AS2129 and AS4087 Class 14
 Alternative specs are available - Refer to Valve Selection Guide for additional info.
 Standard Wafers are not full flange type i.e. flange bolts locate wafer concentrically and remain visible when viewing assembly. Wafers are fitted with an o’ring in each face for sealing against smooth flat faced flanges. Gaskets will however be required where grooved, raised or rough cast face flanges are used.
 PVC and Poly Stub Flanges note; Due to smaller I.D. of these flanges/pipes, optional spacers are often required to prevent restriction.

Max Pressure Differential
Max Hydrostatic Pressure
Max Temperature
Compatible Control Rubbers

2000 kPa (for N7 & E7 rubbers only)
 6000 kPa
 60°C for Nitrile control Rubbers - 100°C for EPDM - 200°C for Viton
 Standard Precision P (Non Standard LP, N6, N7, EP, E7, V, HF)

Specifying valves

When ordering these valves, please be sure to specify;

- Body size
- Flange specification (if other than Table D)
- Body material
- Control rubber material and pressure differential range (if other than Precision)
- Flow Rate

www.maric.com
 Ph: +61 8 8431 2281



Maric Constant Flow Valves

Constant Flow Rate Regardless of Pressure



Est. 1963

Availability & Specifications – Maric Flow Control Valves

Designed for mounting between ANSI 150 and ANSI 300 pipe flanges.

Sizes	flow rate ranges avail.	standard no. of control rubbers
25mm	from 0.4 to 114 l/m	1
32mm	from 15 to 114 l/m	1
40mm	from 15 to 233 l/m	1
50mm	from 15 to 342 l/m	1 – 3
65mm	from 15 to 456 l/m	4
80mm	from 15 to 699 l/m	3
100mm	from 15 to 1279 l/m	6
150mm	from 15 to 2320 l/m	12
200mm	from 114 to 4427 l/m	19
250mm	from 114 to 6058 l/m	26
300mm	from 114 to 8854 l/m	38



Dimensions & Weights

Nominal size	25	32	40	50	65	80	100	150	200	250	300
Diameter - ANSI150	66.6	76.2	86.0	104.8	123.9	136.6	174.7	222.3	279.4	339.7	409.6
Diameter - ANSI 300	73.1	82.6	95.3	111.2	130.2	149.2	181.0	250.8	308.0	361.9	422.3
Thickness	22.0	22.0	22.0	22.0	22.0	22.0	24.0	24.0	28.0	32.0	40.0
Approx Weight Kg	0.6	0.7	0.9	1.2	1.2	1.6	2.7	5.0	11.0	19.0	31.0

Standard Performance

Unless otherwise specified, **standard** Nitrile “**Precision**” type control rubbers are fitted giving the valve the following standard performance; (Refer also to available; Product Data – Control Rubbers – Precision)

Pressure Differential Range
Flow Rate Accuracy
Headloss
Available Flow Rates

140 – 1000 kPa
 +/- 10%
 140 kPa at rated flow. (At lower than rated flows headloss reduces significantly.)
 .4 / .45 / .5 / .55 / .63 / .7 / .8 / .9 / 1.0 / 1.1 / 1.2 / 1.3 / 1.5 / 1.6 / 1.8 / 2.0 / 2.3 / 2.5 / 2.8 / 3.0 / 3.2 / 3.5 / 4.0 / 4.5 / 5.0 / 5.5 / 6.3 / 7.0 / 8.0 / 9.0 / 10 / 11 / 12 / 13 / 15 / 16 / 18 / 20 / 23 / 25 / 28 / 32 / 36 / 41 / 45 / 49 / 54 / 59 / 66 / 73 / 82 / 91 / 102 / 114 / 125 / 138 / 150 / 162 / 180 / 199 / 216 / 233 lpm up to 8854 lpm

Materials

Body
Sealing O’Rings

316 Stainless Steel to ASTM484/A276
 Nitrile, potable water approved to AS4020 or EPDM or Viton if applicable

Flange Specification

Suits ANSI flanges (ASME/ANSI B16.5)
 Alternative specs are available - *Refer to Valve Selection Guide.*
 Standard Wafers are not full flange type i.e. flange bolts locate wafer concentrically and remain visible when viewing assembly.
 Wafers are fitted with an o’ring in each face for sealing against smooth flat faced flanges. Gaskets will however be required where grooved, raised or rough cast face flanges are used.
 PVC and Poly Stub Flanges note; Due to smaller I.D. of these flanges/pipes, optional spacers are often required to prevent restriction.

Max Pressure Differential
Max Hydrostatic Pressure
Max Temperature
Compatible Control Rubbers

2000 kPa (for N7 & E7 rubbers Only)
 6000 kPa
 60°C for Nitrile control rubbers - 100°C for EPDM - 200°C for Viton
 Standard Precision P (Non Standard LP, N6, N7, EP, E7, V, HF)

Specifying valves

When ordering these valves, please be sure to specify;

- Body size
- Flange specification (ANSI 150 or otherwise)
- Body material
- Control rubber material and pressure differential range (if other than Precision)
- Flow Rate

www.maric.com
 Ph: +61 8 8431 2281





AUSTRALIA
Maric Constant
Flow Valves



Product Data

Insert Valve bodies

Plain inserts - Brass and PVC

Special inserts for water meters and tails

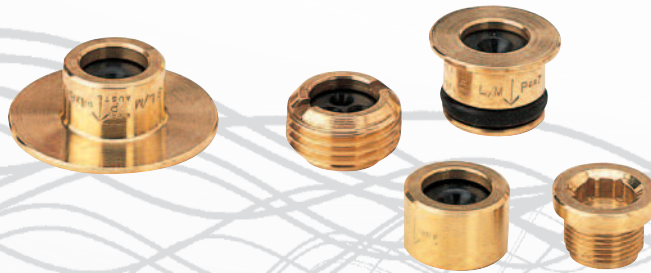
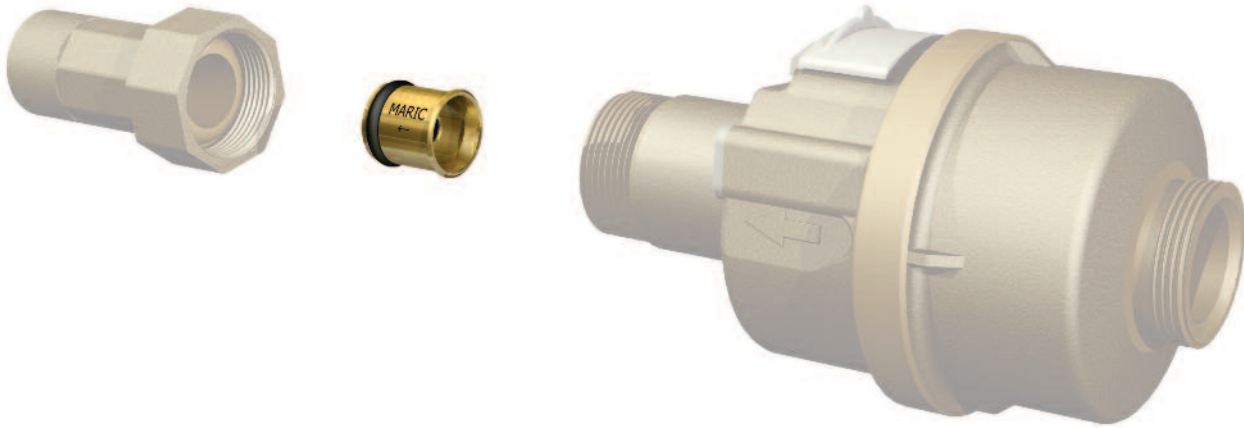

Exported
Globally

www.maric.com

V1022

Constant Flow Rate Regardless of Pressure



Est. 1963

Availability & Specifications – Maric Flow Control Valves

Sizes and flow rate ranges available

DN6	from 0.15 to 9 l/m
DN15	from 0.4 to 23 l/m
DN20	from 8 to 54 l/m
DN25	from 15 to 114 l/m
DN40	from 114 to 233 l/m

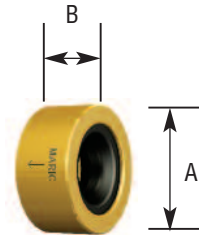

Available flow rates litres/minute

.15 / .2 / .25 / .3 / .35 / .4 / .45 / .5 / .55 / .63 / .7 / .8 / .9 / 1.0 / 1.1 / 1.2 / 1.3 / 1.5 / 1.6 / 1.8 / 2.0 / 2.3 / 2.5 / 2.8 / 3.2 / 3.5 / 4.0 / 4.5 / 5.0 / 5.5 / 6.3 / 7.0 / 8.0 / 9.0 / 10 / 11 / 12 / 13 / 15 / 16 / 18 / 20 / 23 / 25 / 28 / 32 / 36 / 41 / 45 / 49 / 54 / 59 / 66 / 73 / 82 / 91 / 102 / 114 / 125 / 138 / 150 / 162 / 180 / 199 / 216 / 233 /

Pressure Differential Range	140 – 1000 KPA
Flow Rate Accuracy	+ / - 10%
Headloss	140 kPa at rated flow. (At lower than rated flows headloss reduces significantly.)

Temperature Range	Brass; 0 – 60°C	PVC; 0 – 50°C
--------------------------	-----------------	---------------

Performance Graph; Typical of PRECISION valves irrespective of body size or flow rate

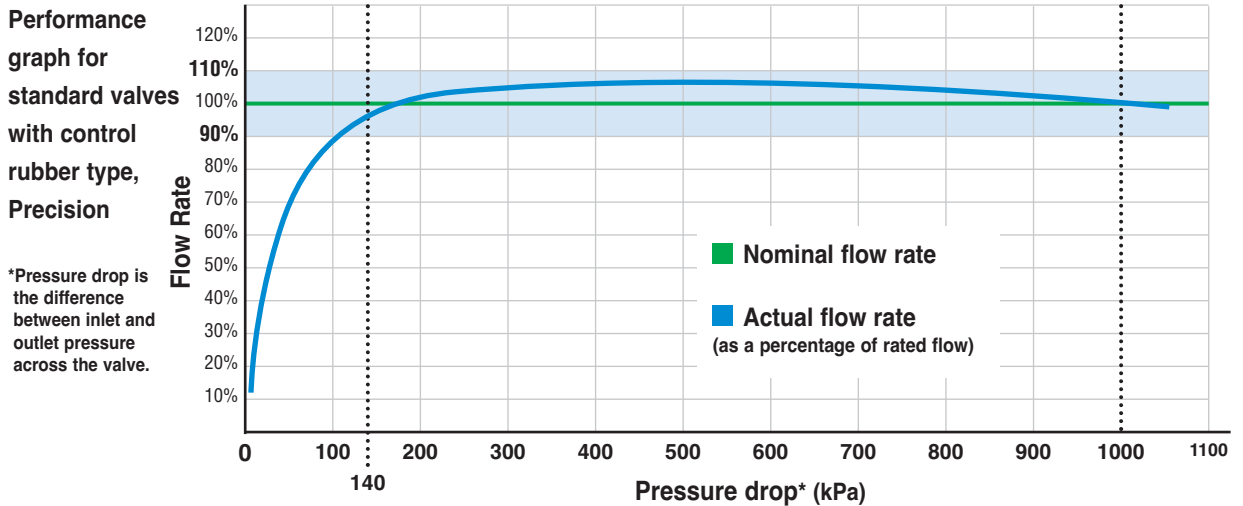

Quality & Construction	Valves comply to WaterMark Technical Standards WMTS-037.1	
Materials	Body	Brass "DR" Brass to AS1567 - 352
		PVC Grey UPVC, Special grade to suit potable water requirements to AS4020
	Control rubber	Nitrile butadiene, potable water approved to AS4020

Insert Dimensions & Weights

Nominal size (DN)	6	15	20	25	40
Diameter "A"	12.45	18.40	26.70	37.85	50.40
Length "B"	8.0	11.1	15.1	17.5	22.4
Brass Kg	0.005	0.013	0.027	0.065	-
PVC Kg	0.001	0.003	0.008	-	0.043

Non-Standard Specifications - Higher flow rates, Kwyflo (quiet) valves, EPDM or Viton control rubbers, Higher or lower pressure ranges, or higher temperature ranges may be available in certain valve configurations.

Refer to Product Data - Control Rubbers for additional information.



Maric Constant Flow Valves

Constant Flow Rate Regardless of Pressure



Est. 1963

PRODUCT DATA – Standard specifications

Comprehensive Listing Available Separately



Available flow rates litres/minute

.15 / .2 / .25 / .3 / .35 / .4 / .45 / .5 / .55 / .63 / .7 / .8 / .9 / 1.0 / 1.1 / 1.2 / 1.3 / 1.5 / 1.6 / 1.8 / 2.0 / 2.3 / 2.5 / 2.8 / 3.2 / 3.5 / 4.0 / 4.5 / 5.0 / 5.5 / 6.3 / 7.0 / 8.0 / 9.0 / 10 / 11 / 12 / 13 / 15 / 16 / 18 / 20 / 23 / 25 / 28 / 32 / 36 / 41 / 45 / 49 / 54 / 59 / 66 / 73 / 82 / 91 / 102 / 114 / 125 / 138 / 150 / 162 / 180 / 199 / 216 / 233 /

Pressure Differential Range 140 – 1000 KPA
Flow Rate Accuracy + / - 10%
Headloss 140 kPa at rated flow. (At lower than rated flows headloss reduces significantly.)

Temperature Range

Performance Graph; Typical of **PRECISION** valves irrespective of body size or flow rate

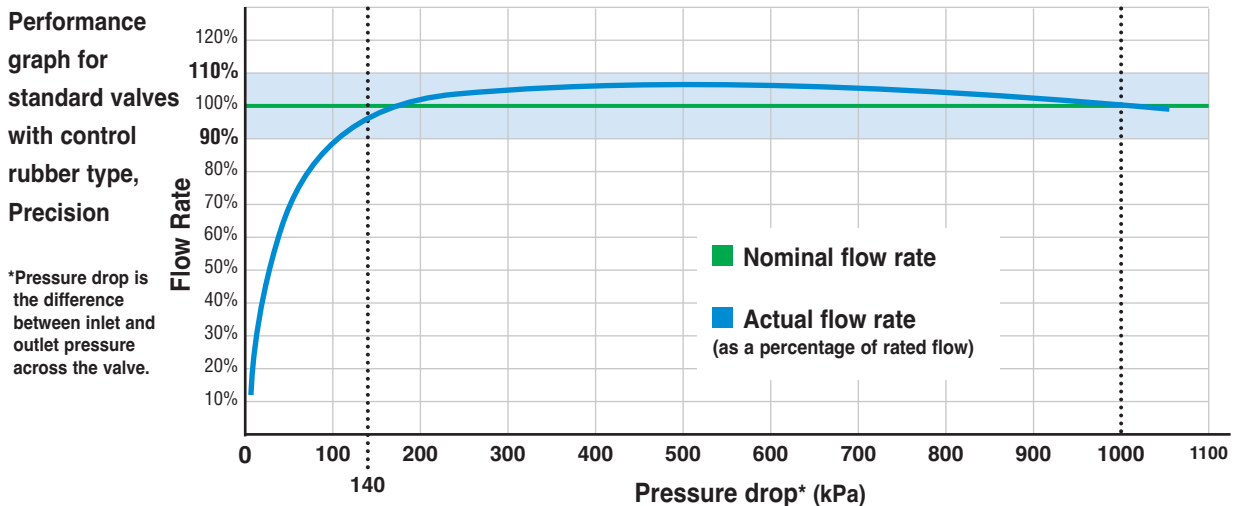

Quality & Construction

Materials	Body	Brass	Valves comply to WaterMark Technical Standards WMTS-037.1
		PVC	"DR" Brass to AS1567 - 352
	Control rubber		Grey UPVC, Special grade to suit potable water requirements to AS4020
	O'Rings		Nitrile butadiene, potable water approved to AS4020
			Nitrile, potable water approved to AS4020

Insert Dimensions

Non-Standard Specifications - Higher flow rates, Kwyflo (quiet) valves, EPDM or Viton control rubbers, Higher or lower pressure ranges, or higher temperature ranges may be available in certain valve configurations. Refer to Product Data - Control Rubbers for additional information.

www.maric.com
Ph: +61 8 8431 2281





AUSTRALIA
Maric Constant
Flow Valves



General Information

- Installation Instructions
- Operating Instructions
- Maintenance
- Spare Parts
- Troubleshooting Guide
- Valve Identification
- Noise
- Life Expectancy
- After Sales Service



Exported
Globally

www.maric.com

V1022



Product Data

Installation Instructions

All Valve Types;

Valves must be installed the right way around or immediate valve failure may result. A direction of flow arrow is stamped on the outside diameter of the valve body.

It is recommended to orientate the valves stamped data toward the top, or in such a position to facilitate identification.

Bends or elbows immediately in front of valve will not affect the valves performance, however due to the relative high velocity of the water jets exiting the valve, and possible erosion issues, it is recommended that a straight pipe, the length of approximately the nominal diameter of the fitting, be fitted on valves outlet.

Use of Sieves;

The installation of a sieve upstream of the Maric valve is recommended where solid particles larger than one third of the valves orifice diameter is likely to be encountered. The mesh aperture should be around one quarter to one third of the valves orifice diameter.

Screwed Valves;

Refer to direction of flow arrow. Standard threads are BSPT (sealing/tapered) , Male series R, Female RP. The use of thread tape or similar is recommended for a watertight seal.

PVC Screwed Valves;

Maximum recommended tightness is hand tight, plus a quarter turn."

Wafer Type Valves;

Wafers are fitted with an o'ring in each face for sealing against smooth, flat faced flanges. Gaskets will however be required where grooved, raised or rough cast face flanges are used.

Standard wafers are orifice plate style,

i.e. they are not **full flange** type, see diagram
Flange bolts will locate the wafer concentrically, and remain visible between the flanges when viewing the assembly.

There will be some clearance (generally around 2 to 3mm, but up to 5 mm on larger wafer sizes) between wafer O.D. and the bolts. This is normal. The wafer should be located as close as possible to concentric prior to final clamping.

Flanges must have aperture dimensions of no less than the nominal size of the flange. i.e. a 100NB flange, must have an internal diameter, (where it butts up against the wafer valve), of no less than 100.0 mm. If it is less than this, then the flanges will either require machining (chamfering) at an angle of 45 degrees, out to the nominal diameter, or adaptors, below, fitted. Otherwise the valves inlet and outlet orifices will be covered more than is permitted and will restrict flow rate to less than the specification of the valve. It is common for a large portion of the outer aperture of the inlet orifices to be covered by the flanges, and up to 3mm of the outlet orifices to be covered by the flanges. This is normal, and will not affect performance.

PVC & Poly stub flanges usually have smaller inside diameters which can restrict valve flow as above. Therefore, optional adaptors are usually required. Contact Maric for a recommendation.

Insert Type Valves;

Installation varies according to application. They must be installed as per the direction of flow arrow.



Maric Constant Flow Valves

Constant Flow Rate Regardless of Pressure



Est. 1963

Operating Instructions;

Maric valves automatically maintain a constant, pre-set, flow rate, irrespective of pressure (within a range), by means of a rubber control ring, whose orifice diameter varies, as the pressure differential across it varies. The greater the pressure, the smaller the orifice, and vice versa. Therefore constant flow rate. The valve has no external actuators and requires no adjustments. Provided the valve is supplied with a pressure sufficient to produce a pressure differential across it within its specified range, then the valve will deliver its rated flow within rated flow rate accuracy. Refer also to Installation Instructions for more information.

Maintenance; No specific maintenance requirements are pertinent to Maric Flow Control Valves.

Spare Parts;

Due to the valves unique design and lack of wearing components, spare parts are not available for Maric flow control valves.

Troubleshooting Guide;

Problem	Cause	Remedy
No flow	Valve is blocked There is no pressure differential across valve	Remove valve and clear the blockage – Install sieve Turn on the supply to the valve
Flow rate is below spec	Valve is installed backward Flow rate has been measured incorrectly Pressure differential across valve is below the minimum requirement Pressure differential across valve is above its maximum limit Valve is partly blocked Flange bore is too small - restricting flow Incompatible environment has attacked control rubber affecting control rubber performance	Turn it around Check or recalibrate and re-measure Increase pressure to within the pressure differential range of the valve Reduce pressure to within the pressure differential range of the valve Clear blockage Chamfer or bore out flanges to the nominal bore of the pipe Replace valve with one fitted with control rubber suitable for the environment
Flow rate is above spec	Control rubber has blown through valve orifice resulting from excessive pressure differential or a high pressure spike Flow rate has been measured incorrectly Valve is installed backward Control rubber has blown through orifice due to valve being installed backwards Incompatible environment has caused control rubber to harden Incompatible environment has dissolved rubber	Replace control valve and assess installation for cause of excessive pressure Check or recalibrate and re-measure Turn it around Replace valve and re-install in accordance with direction of flow arrow stamped on body Replace valve with one fitted with control rubber suitable for the environment Replace valve with one fitted with control rubber suitable for the environment
Valve is noisy	Valves can be noisy. Noise is often proportional to valve size, and pressure differential across it. If none of the techniques to the right are a practical solution to your issue, please contact a Maric Rep for other possible alternative remedies	<ul style="list-style-type: none"> • Use Kwyflo valves designed for quiet operation • Reduce or increase pressure differential • Relocate valve or bury it underground • Lag the valve and outlet pipe in an acoustic enclosure or material • Alter the valves outlet pipework construction, to alter its resonant characteristics

www.maric.com

Ph: +61 8 8431 2281



Valve Identification; Valves are stamped with; Maric Australia, WaterMark details if applicable, direction of flow arrow, flow rate, manufacture date and a part number. Comparing the part number with the “Establishing Part Numbers” page in the product catalogue, will enable identification of full valve specifications.

Noise; Both flow rate and external factors affect the noise emitted from a maric valve. In most situations the noise level will be between 75 and 85 dB. However in some circumstances may attain 93 dB.

Life Expectancy; Approximately 20 years, depending on accuracy required. Flow rate increases generally one half to one percent per year. Therefore in 20 years time, flow rate may be 10% to 20 % higher than when valve was originally supplied. Poor water quality may accelerate aging.

After Sales Service; Your nearest Maric distributor or representative, as listed on our website; www.maric.com